



ZHEJIANG GONGDONG
MEDICAL TECHNOLOGY CO.,LTD

Products Catalog

From good to professional,
We will do better!



ZHEJIANG GONGDONG
MEDICAL TECHNOLOGY CO.,LTD

Add:NO.10, Beiyuan, Ave., Huangyan,

Taizhou,Zhejiang, China

Tel:0086-576-84115678

Fax:0086-576-84050789

P.CI318020

E-mail:crm@chinagongdong.com

<http://www.chinagongdong.com>

www.chinagongdong.com





ALWAYS BE THE LEADER IN CHINA MEDICAL CONSUMABLES AREA

Zhejiang Gongdong Medical Technology Co., Ltd. was found in 1985 in the developed coastal city Huangyan, Taizhou. It's specialized in manufacturing disposable medical testing products. After thirty-two years' efforts, it has become a well-known company in the field of medical and laboratory wares in China, and also the member unit of China Association for Medical Device Industry. Nowadays it is regarded as a leader in the field of disposable medical wares.

Following by the concept of promoting health care, relying on technological innovation, Gongdong improves its product's technology content constantly, to make sure to provide the safe and effective products to the people. Until now it has five big series of items, but more than 300 types of products.

In order to follow the market trend and seek a far-reaching development, Gongdong got ISO and CE certificates in 2001, and also started to do exportation in the same year. Based on its famous brand name and many years' development experience, Gongdong has made great achievements: It's vacuum tube, vaginal speculum and petri dish are highly enjoyed, particularly in the United States, Japan market; And it has built up a close business relation with some world-top 500 global corporations from medical treatment industry; Now, some famous global corporations from gene science and life field of science, start to cooperate with Gongdong, which makes Gongdong have further development in this advanced field of science.

Today, when the world economy develops steadily, but people requires more on medical and health care, which for sure pushes on development of medical research, diagnosis and supplies industries. It was just under this situation. Gongdong continues to be the leader in medical equipment industry.

While obtaining above great achievement, Gongdong also pay high attention to the talented, emphasizes on "People-Oriented, Team-Oriented", the employee of it understand well at it's policy "High Efficiency, High Quality, Development with Prosperity Together".

In future, Gongdong will redouble its' effort, keep improving products' technology and its' service, to develop more high-tech and new products, to contribute more to human being.



pursue innovation forever

motivity of Gongdong's development

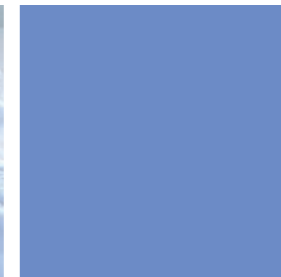

Product research and development also requires technological innovation

Gongdong always takes improving the scientific and technological content of products, increasing investment in technological innovation and lifting products' independent research and development capability and art improvement ability as its the main objectives. And it pushes the Chinese medical consumable materials forward in a high level.



PULL ALL TOGETHER, AS QUALITY ALWAYS THE FIRST

Quality is the key to the success of an enterprise. Gongdong persists in top-down collaboration, which makes it possible for the quality to improve constantly and tend to be perfect.



High Quality High Efficiency development with Prosperity together

Efficiency stressing speed, character striving for quality and the harmonious unification of speed and quality, which create Gongdong's belief in high standards of products.











Gongdong has always adhered to this idea, so that it can walk in the forefront of medical consumables industry.





- Golden vac 01**
- Specimen containers 14**
- 26 Petri dish & loops**
- Nursing plastic ware 30**
- 37 Centrifuge tubes & racks**
- Pipette tips & boxes 41**
- 45 Culture plate & pipettes**
- Test tubes & racks 51**
- 58 CUVETTES**
- CUVETTES 65**
- 68 Pharmaceutical packaging material**

Category	Item	Additive	Cap Color	Tube material	Tube cap	Tube Size (mm)	Test Item
Serum Blood Collection Tube	Plain Tube	Plain	Red	Glass/Plastic		13*75 13*100 16*100	Clinical Biochemistry, Immunology and Serology Test
						16*100	
	Pro-coagulation Tube	Clot Activator	Red	Glass/Plastic		13*75 13*100 16*100	
						16*100	
	Gel & Clot Activator Tube	Gel & Coagulant	Yellow	Glass/Plastic		13*75 13*100 16*100	
						16*100	
Whole Blood Collection Tube	EDTA Tube	Sprayed K2EDTA/ Sprayed K3EDTA	Purple	Glass/Plastic		13*75 13*100 16*100	Haematology Test (Blood Routine Examination)
						16*100	
	ESR Tube	3.8% Sodium Citrate Buffer(0.129mol/L)	Black	Glass/Plastic		13*75	Erythrocyte Sedimentation Rate Test
Glass						8*120	

Category	Item	Additive	Cap Color	Tube material	Tube cap	Tube Size (mm)	Test Item
Plasma Blood Collection Tube	Coagulation Tube	3.2% Sodium Citrate Buffer(0.109mol/L)	Blue	Glass/Plastic		13*75 13*100	Coagulation Function Test
						10.25*64	
	Heparin Tube	Sodium Heparin/ Lithium Heparin	Green	Glass/Plastic		13*75 13*100 16*100	Clinical Chemistry for Emergency Treatment, Blood Rheology Test
						16*100	
	Gel & Heparin Tube	Gel & Sodium Heparin/ Gel & Lithium Heparin	Green	Glass/Plastic		13*75 13*100 16*100	
						16*100	
Glucose Tube	Sodium Fluoride & Sodium Heparin/ Sodium Fluoride & EDTA/ Sodium Fluoride & Potassium Oxalate	Grey	Glass/Plastic		13*75 13*100	Glucose and Lactate Test	
					16*100		
EDTA & Gel Tube	Gel & Sprayed K2EDTA/ Gel & Sprayed K3EDTA	Purple	Glass/Plastic		13*75 13*100 16*100	Molecular Biology Test (Such as PCR)	
					16*100		

Serum Blood Collection Tube

Golden Vac™ serum blood collection tube promises to provide non-polluting and non-differential original blood specimen for medical test. After centrifugation, serum can be separated from blood cells and fibrin effectively. Serum tube includes 3 kinds of tubes: Plain Tube with red cap, Pro-coagulation Tube with red cap and Gel & Clot Activator Tube with yellow cap.

Serum (Plain) Tube



Plain Tube aims to obtain serum specimen for biochemistry, immunology and serology tests in clinical inspection. Its main merit is that serum separate out of blood cells and fibrin naturally, so its physico-chemical properties are keeping nonpolluted. The intact serum is suitable for a wide range of laboratory operation, routine clinical chemistry, immunology and serology.

Item	Specification	Qty/Cs
GD020A	Red cap, Plain 13*75mm, 2ml	1200
GD030A	Red cap, Plain 13*75mm, 3ml	1200
GD040A	Red cap, Plain 13*75mm, 4ml	1200
GD050A	Red cap, Plain 13*75mm, 5ml	1200
GD060A	Red cap, Plain 13*100mm, 6ml	1200
GD070A	Red cap, Plain 13*100mm, 7ml	1200
GD090A	Red cap, Plain 16*100mm, 9ml	1200
GD0100A	Red cap, Plain 16*100mm, 10ml	1200
GD090AR	Rubber stopper, Plain 16*100mm, 9ml	1200
GD0100AR	Rubber stopper, Plain 16*100mm, 10ml	1200

Serum (Clot Activator) Tube



Pro-coagulation Tube aims to obtain serum specimen, which is used for biochemistry and immunology tests. The interior wall is finely coated with coagulant which may promote the blood coagulation after collection. The appropriate amount of coagulant make blood coagulation in a relatively short time, avoiding potential hemolysis problem which caused by too rapid clotting. Finally, transparent serum can be separated after centrifugation.

Item	Specification	Qty/Cs
GD020CA	Red cap, Clot Activator 13*75mm, 2ml	1200
GD030CA	Red cap, Clot Activator 13*75mm, 3ml	1200
GD040CA	Red cap, Clot Activator 13*75mm, 4ml	1200
GD050CA	Red cap, Clot Activator 13*75mm, 5ml	1200
GD060CA	Red cap, Clot Activator 13*100mm, 6ml	1200
GD070CA	Red cap, Clot Activator 13*100mm, 7ml	1200
GD090CA	Red cap, Clot Activator 16*100mm, 9ml	1200
GD0100CA	Red cap, Clot Activator 16*100mm, 10ml	1200
GD090CAR	Rubber stopper, Clot Activator 16*100mm, 9ml	1200
GD0100CAR	Rubber stopper, Clot Activator 16*100mm, 10ml	1200

Gel & Clot Activator Tube aims to obtain high quality serum specimen for biochemistry, immunology and serology tests in clinical inspection, Inside the tube there is some gel present at the bottom, which is a pure substance and is very stable in physico-chemistry properties. Otherwise, the gel can avoid high-temperature decomposition and small molecules precipitation, hence it greatly reduces the risk of testing equipment clogging.

Gel & Clot Activator Tube



Gel & Clot Activator Tube



Item	Specification	Qty/Cs
GD040SGC	Yellow cap, Separate Gel+Clot Activator 13*75mm, 4ml	1200
GD040SGC2	Yellow cap, Separate Gel+Clot Activator 13*100mm, 4ml	1200
GD050SGC	Yellow cap, Separate Gel+Clot Activator 13*100mm, 5ml	1200
GD060SGC	Yellow cap, Separate Gel+Clot Activator 13*100mm, 6ml	1200
GD080SGC	Yellow cap, Sepearate Gel+Clot Activator 16*100mm, 8ml	1200
GD085SGC	Yellow cap, Sepearate Gel+Clot Activator 16*100mm, 8.5ml	1200
GD080SGCR	Rubber stopper, Separate Gel+Clot Activator 16*100mm, 8ml	1200
GD085SGCR	Rubber stopper, Separate Gel+Clot Activator 16*100mm, 8.5ml	1200

Whole Blood Collection Tube

Golden Vac™ whole blood collection tube promises to provide non-polluting and non-differential original blood specimen for medical test, doesn't require separation of plasma or cells. It includes 2 kinds of tubes: EDTA Tube with Purple cap, ESR Tube with black cap.

EDTA Tube



EDTA Tube is widely used for clinical haematology test, especially for routine blood examination. Our automatic sampling instrument finely and accurately spray additives onto the interior tube wall, to ensure the mixing speed and the anticoagulation effect. EDTA Tube is very convenient to use for it can be directly put on the analyzer to detect without opening the cap.

EDTA & Gel Tube



Item	Specification	Qty/Cs
GD020EK3	Purple cap, EDTA K3, 13*75mm, 2ml	1200
GD030EK3	Purple cap, EDTA K3, 13*75mm, 3ml	1200
GD040EK3	Purple cap, EDTA K3, 13*75mm, 4ml	1200
GD050EK3	Purple cap, EDTA K3, 13*75mm, 5ml	1200
GD060EK3	Purple cap, EDTA K3, 13*100mm, 6ml	1200
GD070EK3	Purple cap, EDTA K3, 13*100mm, 7ml	1200
GD080EK3	Purple cap, EDTA K3, 16*100mm, 8ml	1200
GD090EK3	Purple cap, EDTA K3, 16*100mm, 9ml	1200
GD0100EK3	Purple cap, EDTA K3, 16*100mm, 10ml	1200
GD080EK3R	Rubber stopper, EDTA K3, 16*100mm,8ml	1200
GD090EK3R	Rubber stopper, EDTA K3, 16*100mm, 9ml	1200
GD0100EK3R	Rubber stopper, EDTA K3, 16*100mm, 10ml	1200
GD020EK2	Purple cap, EDTA K2, 13*75mm, 2ml	1200
GD030EK2	Purple cap, EDTA K2, 13*75mm, 3ml	1200
GD040EK2	Purple cap, EDTA K2, 13*75mm, 4ml	1200
GD050EK2	Purple cap, EDTA K2, 13*75mm, 5ml	1200
GD060EK2	Purple cap, EDTA K2, 13*100mm, 6ml	1200
GD070EK2	Purple cap, EDTA K2, 13*100mm, 7ml	1200
GD080EK2	Purple cap, EDTA K2, 16*100mm, 8ml	1200
GD090EK2	Purple cap, EDTA K2, 16*100mm, 9ml	1200
GD0100EK2	Purple cap, EDTA K2, 16*100mm, 10ml	1200
GD080EK2R	Rubber stopper, EDTA K2 16*100mm, 8ml	1200
GD090EK2R	Rubber stopper, EDTA K2 16*100mm, 9ml	1200
GD0100EK2R	Rubber stopper, EDTA K2, 16*100mm, 10ml	1200
GD035EK3G	Purple cap, EDTA K3+Separate Gel, 13*75mm, 3.5ml	1200
GD060EK3G	Purple cap, EDTA K3+Separate Gel, 13*100mm, 6ml	1200
GD085EK3RG	Rubber stopper, EDTA K3+Separate Gel, 16*100mm, 8.5ml	1200
GD085EK3G	Purple cap, EDTA K3+Separate Gel, 16*100mm, 8.5ml	1200

ESR Tube



ESR Tube is mainly used for Erythrocyte Sedimentation Rate test, it contains buffered Sodium Citrate solution with the concentration of 3.8% (0.129mol/L). The mixing ratio of blood to Sodium Citrate is 4:1. It is suitable for the ESR tests for subjects of different gender and ages, with highly related coefficient comparing with the Westgren method..

Item	Specification	Qty/Cs
GD016SC	Black cap, ESR 13*75mm, 1.6ml	1200
GD024SC	Black cap, ESR 13*75mm, 2.4ml	1200
GD032SC	Black cap, ESR 13*75mm, 3.2ml	1200

ESR Tube



ESR Detector

Condition: Within 6 hours to finish the testing.
Lab temperature: 8 to 25°C

Instructions:
1. Put the ESR detector on the level place.
2. Using the ESR tube to collect the blood and mixing well.
3. Put the tube upright on the ESR detector. The tube blue graduation line flush with rack top.
4. Wait 60mins, then read the data that the level of blood go down.
Advantage:

GongDong ESR Fast Detector have a Particular organic glass structure that make the ESR tubes fixed fast and simply, promise it the perpendicular degree of the level direction, and can conveniently adjust the horizon of ESR tubes samples.

Item	Specification	Qty/Cs
GD016ESR	Rubber stopper, ESR Tube 8*120mm, 1.6ml	1200
GD0128ESR	Rubber stopper, ESR Tube 8*120mm, 1.28ml	1200
H1020A	ESR Fast Detector, for 8X120mm,1.6ml tube	10
H1020B	ESR Fast Detector, for 8X120mm,1.28ml tube	10
GD016ESRN	Rubber Stopper, ESR Tube, 9x120mm, 1.6ml	1200

Plasma Blood Collection Tube

Golden Vac™ plasma blood collection tube promises to provide non-polluting and non-differential original blood specimen for medical test. After centrifugation, plasma can be separated from blood cells effectively. Plasma tube includes 5 kinds of tubes: Clotting Tube with blue cap, Heparin Tube and Gel & Heparin Tube with green cap, Compound of Sodium Fluoride and Anticoagulant Tube with grey cap, Gel & EDTA Tube with lavender cap.

Coagulation Tube



Coagulation Tube aims to obtain plasma specimen for coagulation function test, it contains buffered Sodium Citrate solution with the concentration of 3.2%(0.109mol/L).The mixing ratio of blood to Sodium Citrate is 9:1. This anticoagulant is sustained and stable, it strictly control the microbial limit, Making sure the APTT test under the excellent Condition.

Item	Specification	Qty/Cs
GD018SC	Blue cap, Coagulation, 3.2% Sodium citrate 13*75mm, 1.8ml	1200
GD027SC	Blue cap, Coagulation, 3.2% Sodium citrate 13*75mm, 2.7ml	1200
GD036SC	Blue cap, Coagulation, 3.2% Sodium citrate 13*75mm, 3.6ml	1200
GD045SC	Blue cap, Coagulation, 3.2% Sodium citrate 13*75mm, 4.5ml	1200
GD018SCD	Blue cap, Coagulation, 3.2% Double wall 13*75mm, 1.8ml	1200
GD027SCD	Blue cap, Coagulation, 3.2% Double wall 13*75mm, 2.7ml	1200

Coagulation Tube(Glass Only)



Item	Specification	Qty/Cs
GD018SC-F	Blue cap, Glass tube,Coagulation, 10.25*64mm(flat bottom), 1.8ml	1000
GD027SC-F	Blue cap, Glass tube,Coagulation, 10.25*64mm(flat bottom), 2.7ml	1000

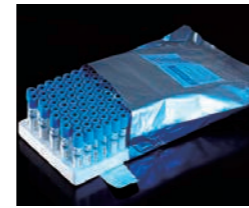
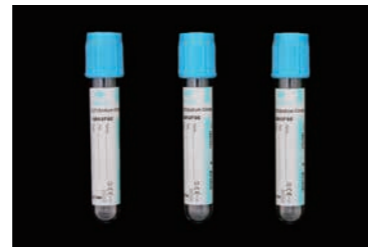

(Aluminium Plastic bag pack for each rack)

Heparin Tube



Heparin Tube aims to obtain plasma specimen, which is used not only for emergency biochemistry tests but also for blood rheology test. Inside the tube wall, where is well sprayed with lithium heparin or sodium heparin which is a kind of anticoagulant activating antithrombins to block the coagulation cascade reaction.

Item	Specification	Qty/Cs
GD030SH	Green cap, Heparin Sodium, 13*75mm, 3ml	1200
GD040SH	Green cap, Heparin Sodium, 13*75mm, 4ml	1200
GD050SH	Green cap, Heparin Sodium, 13*75mm, 5ml	1200
GD060SH	Green cap, Heparin Sodium, 13*100mm, 6ml	1200
GD070SH	Green cap, Heparin Sodium, 13*100mm, 7ml	1200
GD0100SH	Green cap, Heparin Sodium, 16*100mm, 10ml	1200
GD0100SHR	Rubber stopper, Heparin Sodium, 16*100mm, 10ml	1200
GD030LH	Green cap, Heparin Lithium, 13*75mm, 3ml	1200
GD040LH	Green cap, Heparin Lithium, 13*75mm, 4ml	1200
GD050LH	Green cap, Heparin Lithium, 13*75mm, 5ml	1200
GD060LH	Green cap, Heparin Lithium, 13*100mm, 6ml	1200
GD070LH	Green cap, Heparin Lithium, 13*100mm, 7ml	1200
GD0100LH	Green cap, Heparin Lithium, 16*100mm, 10ml	1200
GD0100LHR	Rubber stopper, Heparin Lithium, 16*100mm, 10ml	1200

Gel & Heparin Tube



Gel & Heparin Tube is a kind of anticoagulation tube, aims to obtain high quality plasma specimen for fast emergency biochemistry test. Lying at the bottom of the tube, there is some gel for separating plasma and blood cells, preventing substance from exchanging and keeping the obtained plasma from being blood cell polluted, thus the accuracy of the results will be improved. Otherwise, the specimen could be put into the equipment directly without transferring and kept stable in cold storage for 48hs, so that well meets the quality requirement of retest.

Item	Specification	Qty/Cs
GD030SHG	Green cap, Heparin Sodium+Gel, 13*75mm, 3ml	1200
GD040SHG	Green cap, Heparin Sodium+Gel, 13*75mm, 4ml	1200
GD050SHG	Green cap, Heparin Sodium+Gel, 13*100mm, 5ml	1200
GD085SHG	Green cap, Heparin Sodium+Gel, 16*100mm, 8.5ml	1200
GD030LHG	Green cap, Heparin Lithium+Gel, 13*75mm, 3ml	1200
GD040LHG	Green cap, Heparin Lithium+Gel, 13*75mm, 4ml	1200
GD050LHG	Green cap, Heparin Lithium+Gel, 13*100mm, 5ml	1200
GD085LHG	Green cap, Heparin Lithium+Gel, 16*100mm, 8.5ml	1200

Glucose Tube



Compound of Sodium Fluoride and Anticoagulant Tube aims to obtain highly stable plasma for blood glucose testing. Sodium Fluoride is a kind of inhibitor of glucose degradation, it has the function of repressing glucose metabolism and degradation. Optional Anticoagulant are Potassium Oxalate, EDTA and Heparin, they could prevent blood coagulation and avoid blood hemolysis. This particular compound additive realise that blood glucose specimen could be cold storage for a long time.

Item	Specification	Qty/Cs
GD020SFH	Gray cap, Sodium Fluoride+Heparin Sodium, 13*75mm, 2ml	1200
GD030SFH	Gray cap, Sodium Fluoride+Heparin Sodium, 13*75mm, 3ml	1200
GD040SFH	Gray cap, Sodium Fluoride+Heparin Sodium, 13*75mm, 4ml	1200
GD050SFH	Gray cap, Sodium Fluoride+Heparin sodium, 13*75mm, 5ml	1200
GD020SNA	Gray cap, Sodium Fluoride+EDTA Naz, 13*75mm, 2ml	1200
GD030SNA	Gray cap, Sodium Fluoride+EDTA Naz, 13*75mm, 3ml	1200
GD050SNA	Gray cap, Sodium Fluoride+EDTA Naz, 13*75mm, 5ml	1200
GD020SP	Gray cap, Sodium Fluoride+Potassium Oxalate, 13*75mm, 2ml	1200
GD030SP	Gray cap, Sodium Fluoride+Potassium Oxalate, 13*75mm, 3ml	1200
GD040SP	Gray cap, Sodium Fluoride+Potassium Oxalate, 13*75mm, 4ml	1200
GD050SP	Gray cap, Sodium Fluoride+Potassium Oxalate, 13*75mm, 5ml	1200
GD6001	Disposable ESR Pipette with prefilled (3.2% Trisodium Citrate) and capped filling tube 100pcs/box*10boxes	

Non Vacuum Blood Tube



Item	Specification	Qty/Cs
GDN050EK3	5ml EDTA K3 Non-vacuum blood collection tube, Green cap	1000
GDN050EK2	5ml EDTA K2 Non-vacuum blood collection tube, Green cap	1000
GDN050A	5ml Plain Non-vacuum blood collection tube, Red cap	1000
GDN050CA	5ml Clot Activator Non-vacuum blood collection tube, Red cap	1000
GDN050SP	5ml Fluoride Oxalate Non-vacuum blood collection tube, Yellow cap	1000
GDN050LH	5ml Lithium Heparin Non-vacuum blood collection tube, Dark Blue cap	1000



Micro Collection Tube



Micro Collection tube is mainly used for peripheral blood collection. It is specially suitable for small children and geriatric patient. The inner surface has an excellent hemorepellency where it is necessary for a good preparation of high quality blood sample.

Capillary Blood Collection Tube



Item	Specification	Qty/Cs
GD005A	Micro Collection tube, Plain, 0.5ml	1000
GD005CA	Micro Collection tube, Clot Activator 0.5ml	1000
GD005EK3	Micro Collection tube, EDTA K3, 0.5ml	1000
GD005EK2	Micro Collection tube, EDTA K2, 0.5ml	1000
GD005LH	Micro Collection tube, Heparin Lithium, 0.5ml	1000
GD005SH	Micro Collection tube, Heparin Sodium, 0.5ml	1000
GD005SFH	Micro Collection tube, Heparin Sodium +Sodim Fluoride, 0.5ml	1000
GD005SGC	Micro Collection tube, Gel+Clot Activator, 0.5ml	1000
GDNM005A	Micro tube (High Type) 0.5ml Plain 0.5ml	1000
GDNM005CA	Micro tube (High Type) 0.5ml Clot activator 0.5ml	1000
GDNM005EK3	Micro tube (High Type) 0.5ml EDTAK3 0.5ml	1000
GDNM005EK2	Micro tube (High Type) 0.5ml EDTAK2 0.5ml	1000
GDNM005LH	Micro tube (High Type) 0.5ml, Gel 0.5ml	1000
GDNM005SGC	Micro tube (High Type) 0.5ml, Gel 0.5ml	1000
GDNM005SFH	Micro tube (High Type) Glucose(Heparin sodium,/ Sodium Fluoride) 0.5ml	1000



Item	Specification	Qty/Cs
GDC005A	Capillary Blood Collection tube, Plain, 0.5ml	1000
GDC005CA	Capillary Blood Collection tube, Clot Activator, 0.5ml	1000
GDC005EK3	Capillary Blood Collection tube, EDTA K3, 0.5ml	1000
GDC005EK2	Capillary Blood Collection tube, EDTA K2, 0.5ml	1000
GDC005LH	Capillary Blood Collection tube, Heparin Lithium, 0.5ml	1000
GDC005SH	Capillary Blood Collection tube, Heparin Sodium, 0.5ml	1000
GDC005SFH	Capillary Blood Collection tube, Heparin Sodium+Sodim Fluoride, 0.5ml	1000
GDC005SGC	Capillary Blood Collection tube, Gel+Clot Activator, 0.5ml	1000

Sharps Container



For sharp container of 3L, 5L, 7L, two kinds of caps are both available.

Item	Specification	Qty/Cs
GDC-01-F	Sharp container, Flip+Ype closure 1L	60
GDC-03-F	Sharp container, Flip+Ype closure 3L	48
GDC-03-X	Sharp container, Rotary+Ype closure 3L	48
GDC-05-F	Sharp container, Flip+Ype closure 5L	32
GDC-05-X	Sharp container, Rotary+Ype closure 5L	32
GDC-07-F	Sharp container, Flip+Ype closure 7L	24
GDC-07-X	Sharp container, Rotary+Ype closure 7L	24
GDC-013-X	Sharp container, Rotary+Ype closure 13L	20



Item	Description of Goods	Cs size	Qty/Cs
SC-01Q	Sharps Container 1 Quart	108*88*170mm	60pcs/ctn
SC-02Q	Sharps Container 2 Quart	108*88*220mm	60pcs/ctn
SC-05Q	Sharps Container 5 Quarts	273*115*282mm	20pcs/ctn
SC-01G	Sharps Container 1 Gallons	258*175*142mm	24pcs/ctn
SC-02G	Sharps Container 2 Gallons	274*175*254mm	24pcs/ctn
SC-06G	Sharps Container 6 Gallons	378*239*391mm	12pcs/ctn
SCT50	Sharps shafe 6.4X1.22 in(16.17X3.1cm)Lxw	500	500pcs/ctn





Needle & Holder

Item	Specification	Qty/Cs
GDN18G	Needle 18Gx1 1/2"	4000
GDN20G	Needle 20Gx1 1/2"	4000
GDN21G	Needle 21Gx1 1/2"	4000
GDN22G	Needle 22Gx1 1/4"	4000
GD-BF22G	Butterfly Needle 22Gx3/4	2000
GDN21GFB	Flash Back Needle 21Gx1"	5000
GDN22GFB	Flash Back Needle 22Gx1"	5000
GD-H	Holder	2000
GD-H1	Holder With Safty Cover	2000
GD-H2	Holder With Quick Release	2000

Item	Description of Goods	Specification	Packing
GDB-01	blood collect tube box	13*75mm	50pcs/in bulk
GDB-02	blood collect tube box	13*100mm	50pcs/in bulk
GDS-01	specimen storage box	13*100mm (pillar base)100 holes	28pcs/cs
GDS-02	specimen storage box	13*75mm (pillar base)100 holes	



Specimen containers



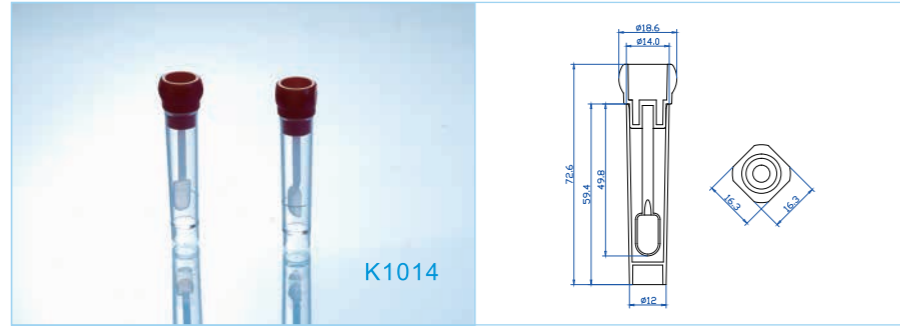

K1014

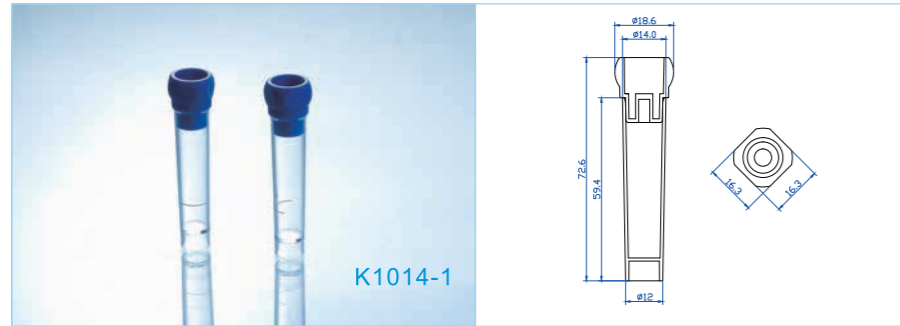

K1014-1

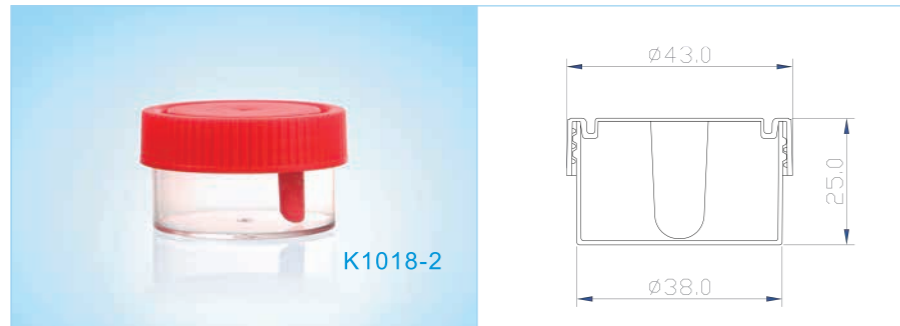

K1018-2

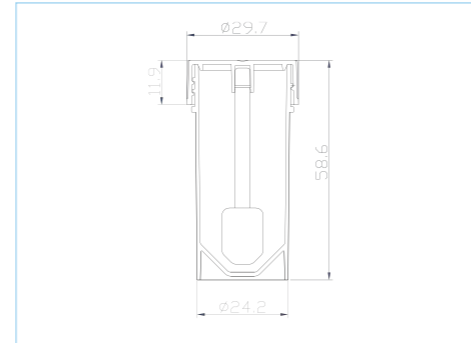

K1018-3



K1011



K1012



K1012-1

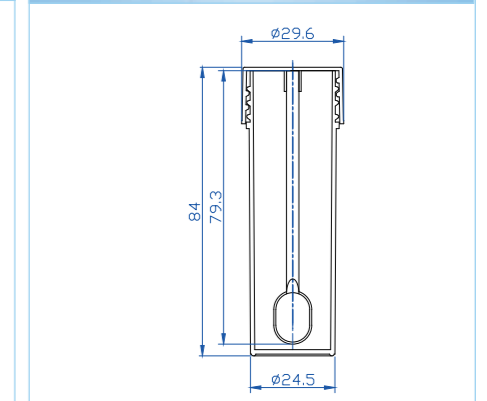
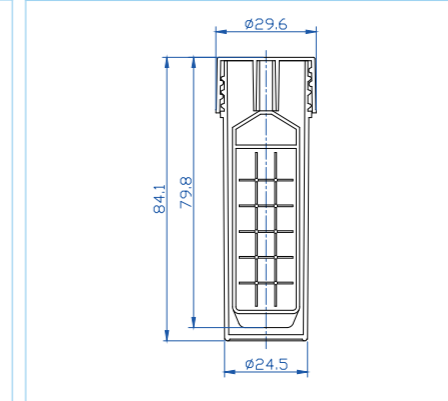
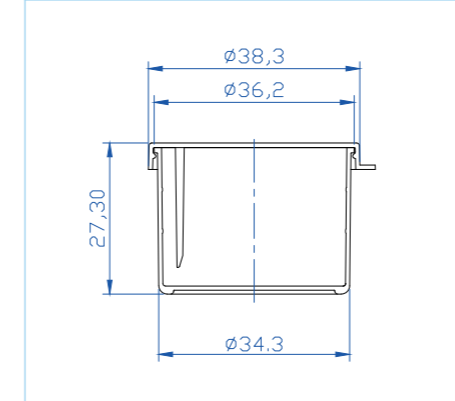

Stool specimen collection

It is for the collection of stool specimen and is clean, convenient and safe. It can form the closed collection and transportation of stool specimen, which effectively prevents the drying, spill and leakage of stool specimen and is good for specimen marking, bulk delivering, and Sampling during specimen testing.

Item	Description of Goods	Quantity (pcs)	Packing
K1014	5ml stool collection tube(with spoon)	2000	25pcs*80bags
K1014-1	5ml stool collection tube(without spoon)	2000	25pcs*80bags
K1018-2	Stool container with spoon 20ml	650	25pcs*26bags
K1018-3	Stool container with spoon 20ml	650	in bulk
K1011	20ml stool container	1000	100pcs*10bags
K1012	25ml culture bottle	650	25pcs*26bags
K1012-1	25ml stool container	650	25pcs*26bags



Item	Description of Goods	Quantity (pcs)	Packing
K1017-2	30ml universal container with spoon PP	650	25pcs*26bags
K1017-3	30ml universal container with spoon PS	650	25pcs*26bags
K1013	60ml stool container	500	in bulk
K1013-1	60ml stool container	500	in bulk
K1013-2	Stool stick	5000	100pcs*50bags



Sputum specimen collection

It is for the collection of sputum specimen and can form the closed collection and transportation of sputum specimen. It is clean, convenient and safe.

Item	Description of Goods	Quantity (pcs)	Packing
K1015	30ml sputum container	500	1pc*500bags
K1018-1	20ml sputum container(NEW)	1000	in bulk
K1017	30ml universal container	650	
K1017-1	30ml sputum container (skirted bottom)	650	25pcs*26bags

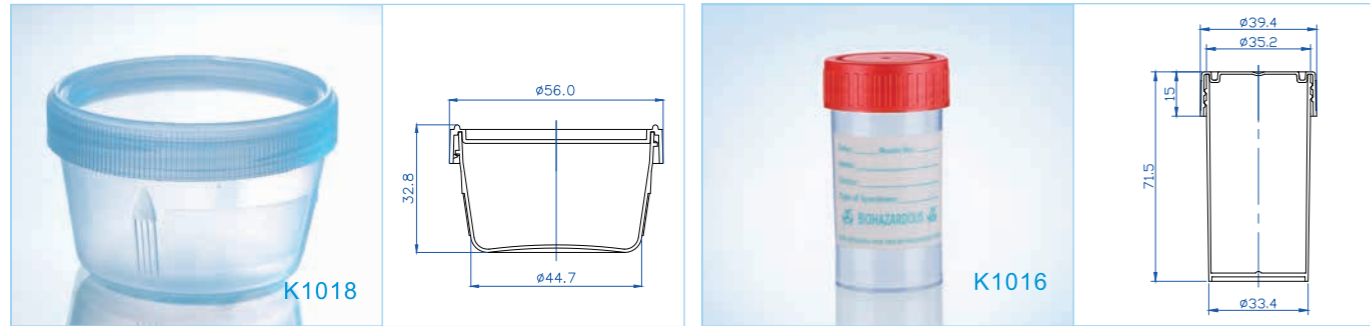

Item	Description of Goods	Quantity _(pcs)	Packing
K1018	30ml sputum container	1000	10pcs*100bags
K1016	40ml sputum container	500	5pcs*100bags
K1019	Sputum cassette	2000	100pcs*10bags
K1023	Mucus trap,40cc	50	1pc/bag*50bags
K1024	Mucus trap,80cc	50	1pc/bag*50bags



Urine specimen collection

It is for the collection of urine specimen. It is made of medical plastic and designed in humanization with thick and even wall. It can form the closed collection, transportation and testing of urine, which has solved a series of problems, such as urine specimen submission, supporting the use of computers, pollution and so on.

- The product use is clean, convenient and safe, which provides a guarantee for the normalization and standardization of urine analysis from the source.

Item	Description of Goods	Quantity _(pcs)	Packing
K1009	Soft urine cup white	10000	in bulk
K1010	Soft urine cup transparent	10000	in bulk
K1025	30ml urine container with mouth on cap,30ml	500	1pc*500pcs



H1016-3

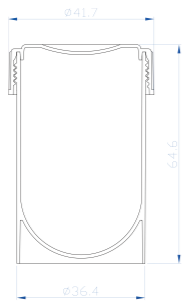

H1016-5

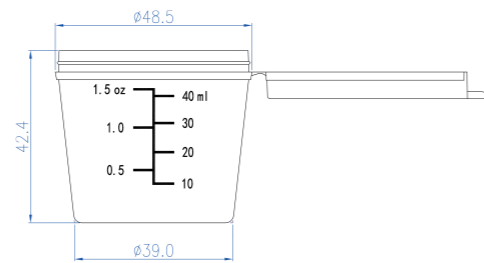

H1016

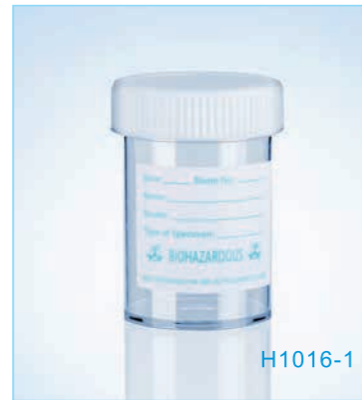
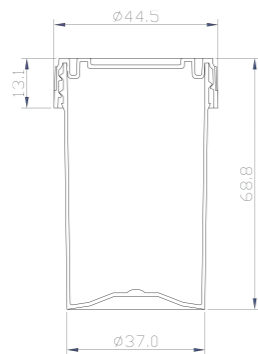

H1016-1

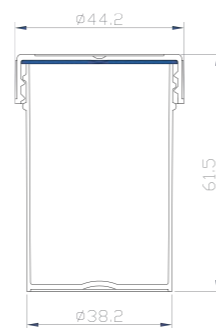

H1016-2

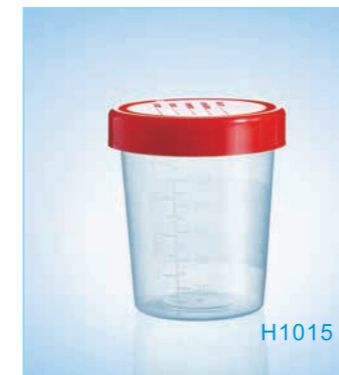
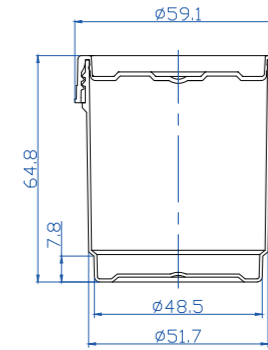

H1015

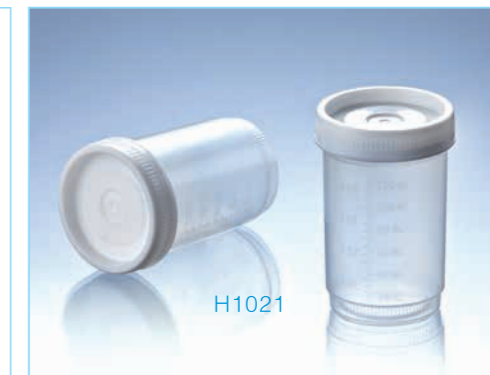
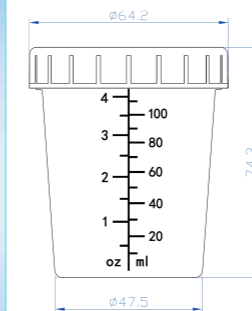

H1021

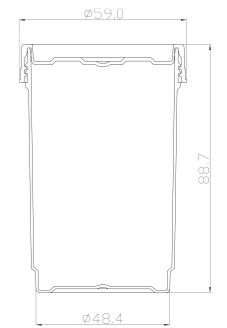

Item	Description of Goods	Quantity (pcs)	Packing
H1016	60ml specimen container	500	1pc*500pcs
H1016-1	60ml specimen container, PS	500	1pc*500pcs
H1016-2	90ml specimen container	500	5pcs*100bags
H1016-3	40ml specimen container	500	1pc*500pcs
H1016-5	40ml renovate urine container	500	50pcs/ctn
H1015	100ml-120ml specimen container	500/1000	Individual Packing/ 20pcs*50bags Bulk Packing
H1021	120ml-140ml Urine container	500	1pc*500pcs

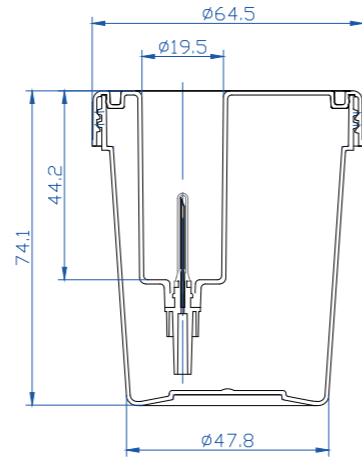

Item	Description of Goods	Quantity (pcs)	Packing
K1026	Urine Transfer Device for Urine Tube, 100ml	250	1pc*250pcs
GD0105UA	Vacuum Urine Tube, Yellow cap No Additive, 16*100mm, 10.5ml	1200	1pc*1200pcs
GD0105UB	Vacuum Urine Tube, Yellow cap Boric Acid, 16*100mm, 10.5ml	1200	1pc*1200pcs
H1026	Urine Storage Container for 24hours, 3000ml	50	
H1027	Urine tube, 16X85mm, 10ml	2000	200pcs*10bags



Transport Swabs, Amies, Snappable Plastic Stick + Viscose head, Swab length: 150mm. Tubes in PP material, Dia. 13*150mm, labelled, Gamma Sterile. Individual Packing. Blue Cap



Transport Swabs, Amies with Charcoal, Snappable Plastic Stick + Viscose head, Swab length: 150mm. Tubes in PP material, Dia. 13*150mm, labelled, Gamma Sterile. Individual Packing. White Cap



Transport Swabs, Cary Blair, Snappable Plastic Stick + Viscose head, Swab length: 150mm. Tubes in PP material, Dia. 13*150mm, labelled, Gamma Sterile. Individual Packing. Red Cap

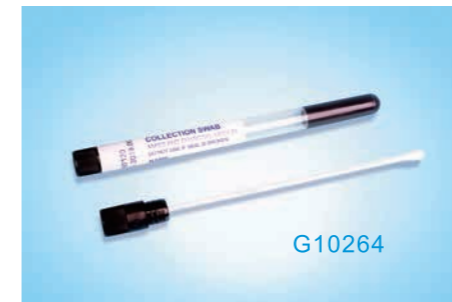

Transport Swabs, Snappable Plastic Stick + Viscose head, Swab length: 150mm. Tubes in PP material, Dia. 13*150mm, labelled, Gamma Sterile. Individual Packing. Black Cap

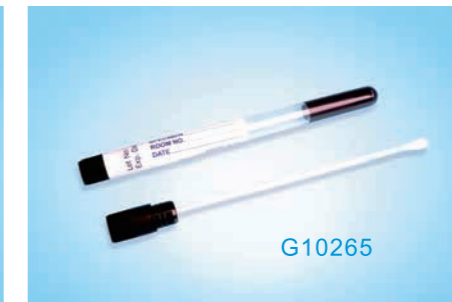

Transport Swabs, Stuart with Charcoal, Snappable Plastic Stick + Viscose head, Swab length: 150mm. Tubes in PP material, Dia. 13*150mm, labelled, Gamma Sterile. Individual Packing. Black Cap

Item	Description of Goods	Quantity (pcs)	Packing
G10261	Transport swab with medium (Amies)	600	50pcs*12boxes
G10262	Transport swab with medium (Amies with charcoal)	600	50pcs*12boxes
G10263	Transport swab with medium (Cary Blair)	600	50pcs*12boxes
G10264	Transport swab with medium (Stuart)	600	50pcs*12boxes
G10265	Transport swab with medium (Stuart with charcoal)	600	50pcs*12boxes



Item	Description of Goods	Quantity (pcs)	Packing
G1022	13*150mm, tube with Swab	1800	150pcs*12bags
G1023	12*75mm, tube with Swab	2000	
G1028	disposable transport sample box		



Petri dish & loops

SYSTEM

The Gongdong Petri dish series are made of imported polystyrene with high quality as raw material. Its smoothness and transparent finish fully achieve the International standard of similar product. It is produced in a 100 thousand stage purification plant where there is no heat source and sterilized by ethylene oxide. Adopt the internationally popular easy tear package, which is simple and convenient and reduce the pollution opportunities in the use of products. Each batch of products is evaluated by growth status observation, test of cell growth rate, test of cell adherence strength, pyrogenicity test and sterility test to ensure product quality. In comparison with similar quality products in the world. The Gongdong petri dish series is suitable for cell, bacteria culture and drug sensitivity test.



Item	Description of Goods	Quantity (pcs)	Packing
K1001	15cm Petri dish	180	Individual Packing
K1002	9cm Petri dish ϕ 9*2.0cm	500	10pcs*50bags
K1020	10ul Sampling Loop	3000	10pcs/bag*300bags
K1021	1ul Sampling Loop	3000	10pcs/bag*300bags
K1022	Needle Type Sampling Loop	3000	10pcs/bag*300bags



● **K1003**

Facilitate the differentiation of bacterial culture programs

● **K1004**

There are three points on the cover to prevent the accumulation of bacterial culture specimens.

Item	Description of Goods	Quantity (pcs)	Packing
K1003	90X15mm Two-Compartment	500	10pcs/bag*50bags
K1004-J	90X15mm Petri Dish	500	10pcs/bag*50bags
K1004-J-3 Vents	90X15mm 3Vents Petri Dish	500	10pcs/bag*50bags
K1004-M	90X15mm for machine Petri Dish	500	10pcs/bag*50bags
K1004-T	90X15mm 3Vents Petri Dish	500	10pcs/bag*50bags

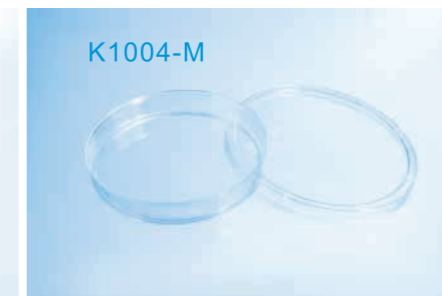

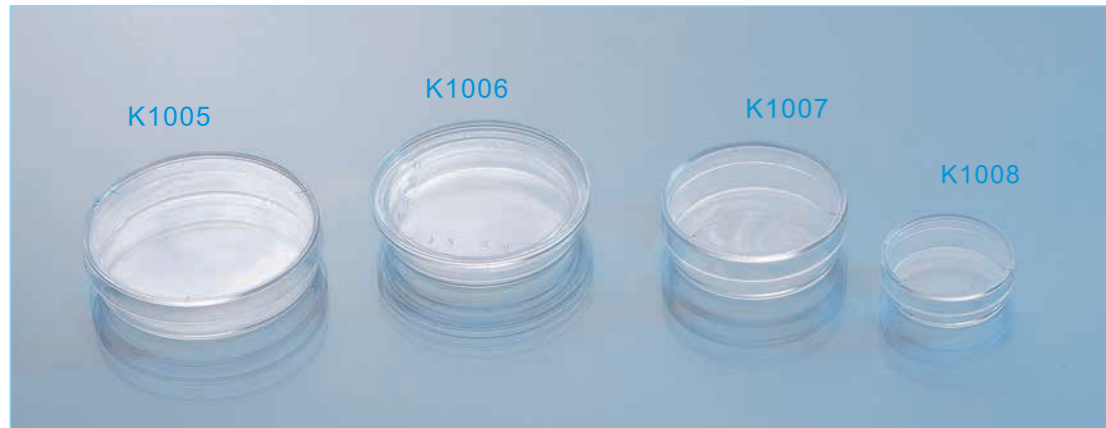

● **K1006** The split format Petri dish is used for bacterial cultures that require the separation of curved surface. The mesh distance is 10mmX10mm. The numbers and alphabetic numbers are convenient for location, identification and counting.

Item	Description of Goods	Quantity (pcs)	Packing
K1005	70x15mm Petri dish	600	10pcs/bag*60bags
K1006	65x15mm Petri dish	650	10pcs/bag*65bags
K1007	55x15mm Petri dish	1000	10pcs/bag*100bags
K1008	30x15 Petri dish	2000	10pcs/bag*200bags
K1009	14cm Petri Dishes	180	10pcs*18bags
K1023	Hook match with mucus trap inner-Φ6.5mm out-Φ9mm	1000	
K1032-L	29cm Cell Scraper	100	Individual
K1032-S	25cm Cell Scraper	100	Individual
K1033	18cm Cell Lifter	100	Individual



Nursing plastic ware

SYSTEM

Gongdong's Vaginal Speculum got FDA approved without any defect. The products are sold well in the United States and other countries. The product design is delicate, humanized and simple to operate. A variety of different specifications of Dressing Cups are suitable for all ages, all kinds of medicine, convenient and clean. All kinds of PP plastic tweezers adopt connecting lever design, more excellent performance, can meet different working requirements.

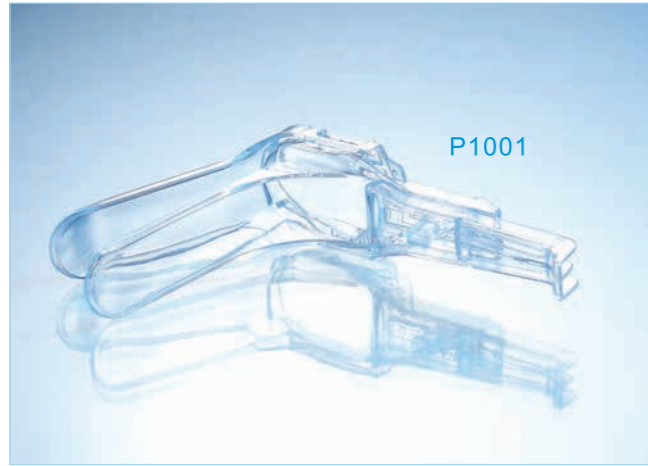

Item	Description of Goods	Quantity (pcs)	Packing
P1001	Vaginal Speculum Large, Middle, Small	100	10pcs/bag*10bags
P1002-L	Vaginal speculum, Light source style, large	80	8pcs/bag*10bags
P1002-M	Vaginal speculum, Light source style, Medium	100	10pcs/bag*10bags
P1002-S	Vaginal speculum, Light source style, Small	100	10pcs/bag*10bags
P1030	Anus speculum, Large, Middle, Small	100	25pcs/bag*4bags
P1039	Anus speculum	100	25pcs/bag*4bags

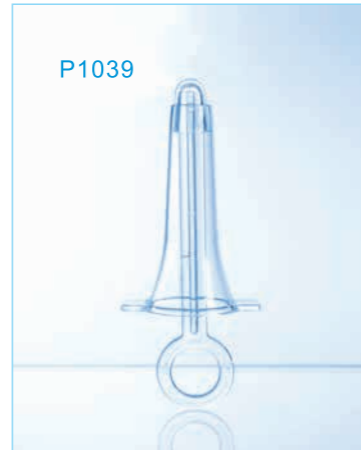

Item	Description of Goods	Quantity (pcs)	Packing
P1012 a/b/c/e	Plastic Tweezers (sterile)	2500	250pcs/bag*10bags
P1012-1	Fine-tipped Tweezers (sterile) 10cm long	2500	250pcs/bag*12bags
P1013	Tweezers with tooth (sterile)	2500	250pcs/bag*10bags
P1014	Long Tweezers tooth (sterile)	2000	200pcs/bag*10bags
P1015	Tweezers without tooth (sterile)	2500	250pcs/bag*10bags
P1016	Blue Tweezers (sterile)	2000	200pcs/bag*10bags





Item	Description of Goods	Quantity (pcs)	Packing
P1020	Sponge Holder 23cm Long	500	50pcs/bag*10bags
P1021	Sponge Holder 18cm Long	500	50pcs/bag*10bags
P1022	Sponge Holder 11cm Long	1200	100pcs/bag*12bags
P1023	Sponge Holder 10cm Long	1200	100pcs/bag*12bags
P1024	Sponge Holder 14cm Long clamp	1200	100pcs/bag*12bags
P1025	Sponge Holder 14cm Short clamp	1200	100pcs/bag*12bags



Item	Description of Goods	Quantity (pcs)	Packing
P1004	Scissors, Blue	1200	100pcs/bag*12bags
P1033	Scissors, Blue	1000	100pcs/bag*10bags
P1038	Tweezres 13cm long	2000	200pcs/bag*15bags
K1034	2.5mm Ear Speculum	8500	34pcs/bag*25bag*10bags
k1035	4.25mm Ear Speculum	8500	34pcs/bag*25bag*10bags



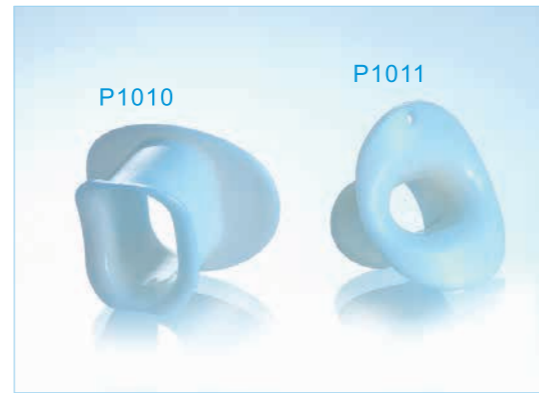
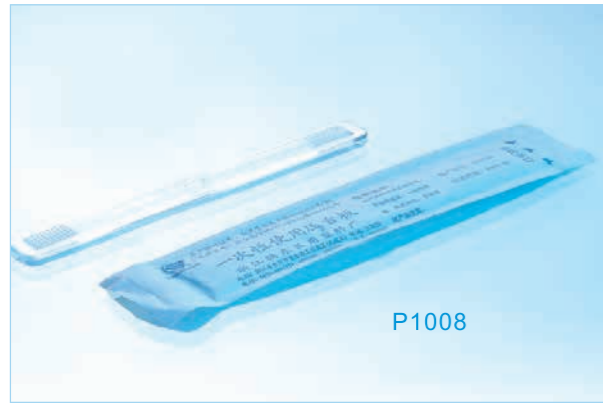

Item	Description of Goods	Quantity _(pcs)	Packing
P1008	Tongue Depressor	2800	200pcs/bag*14bags
P1010	Mouth piece for Endoscope Large	1000	100pcs/bag*10bags
P1011	Mouth piece for Endoscope Medium	1000	100pcs/bag*10bags
P1017	Bite-block-Large	2200	200pcs/bag*11bags
P1017-1	Bite-block-Small	2700	300pcs/bag*9bags
P1018-1	Mouth piece for Endoscope with elastic(Large,Small)	900	Individual Packing



Item	Description of Goods	Quantity _(pcs)	Packing
P1005	3*1Three-color medicine cup	500	25pcs/bag*20bags
P1007	3*1white medicine cup	500	25pcs/bag*20bags
P1003	Transparent dressing bowl(Sterile)	1500	2pcs/packet*50pcs/bags*15bags
P1004-1	Dressing basin(soft)	1000	2pcs/packet*50pcs/bags*10bags
P1004-2	Dressing basin(hard)	80	2pcs/bag*40bags



Centrifuge tubes & Racks

SYSTEM

Centrifuge tube series are made of polypropylene with high quality. The thickness of the tube wall is uniform. The tubes are all marked with scales so that the volume of concentrated liquid can be directly read out, and make it easier to recycle concentrated liquid with straw. The unique sealing cover prevents liquid leakage, and can be sterilized in high temperature and pressure. Match with a variety of centrifuge tube holders.



Item	Description of Goods	Quantity (pcs)	Packing
D1001BB	50ml conical with black graduation blue cap	500	50pcs*10bags
D1001BW	50ml conical with white graduation blue cap	500	50pcs*10bags
D1001GB	50ml conical with black graduation green cap	500	50pcs*10bags
D1001GW	50ml conical with white graduation green cap	500	50pcs*10bags
D1002WW	50ml self-standing white cap	500	50pcs*10bags
D1002BB	50ml self-standing blue cap	500	50pcs*10bags
D1003BB	15ml conical with black graduation blue cap	1000	50pcs*20bags
D1003BW	15ml conical with white graduation blue cap	1000	50pcs*20bags
D1003GB	15ml conical with black graduation green cap	1000	50pcs*20bags
D1003GW	15ml conical with white graduation green cap	1000	50pcs*20bags
D1003-PS	15ml conical with graduation	1000	50pcs*20bags





Item	Description of Goods	Quantity _(pcs)	Packing
D1004	50ml	1000	50pcs*20bags
D1005	15ml conical	1500	150pcs*10bags
D1006	10ml	2000	200pcs*10bags
D1008	5ml*cap	3000	300pcs*10bags
D1013	5ml+cap.	2000	200pcs*10bags
D1015	1.8ml	5000	500pcs*10bags
D1017	1.5 ml linked green cap	6000	500pcs*12bags
D1018	1.5ml linked red cap	6000	500pcs*12bags



D1017 / D1018

It is made of polypropylene with high quality. The thickness of the tube wall is uniform. The connecting pipe cover is provided with a silica gel sealing ring, which has good sealing performance and can prevent leakage pollution during evaporation and transportation.

The color of the cap can be increased according to the needs of the laboratory project.

The thread cap is easy to screw and open.

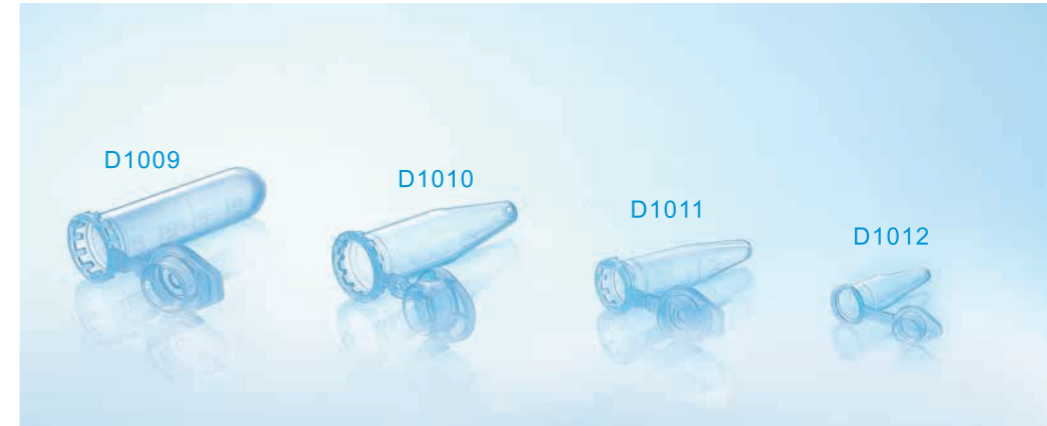

Item	Description of Goods	Quantity _(pcs)	Packing
D1009	2ml	5000	500pcs*10bags
D1010	1.5ml with transparent cap	6000	500pcs*12bags
D1011	0.5ml	12000	1000pcs*12bags
D1012	0.2ml	30000	1000pcs*30bags
D1021	98wells centrifugation tube rack	40	1pc*40bags
D1022	72wells centrifugation tube rack	40	1pc*40bags
D1023	81wells centrifugation tube rack	40	1pc*40bags
D1024	two purpose tube rack	50	1pc*40bags
D1027	two-purpose centrifuge tube rack (front 1.5ml, reverse side 0.5ml)	50	1pc*50bags
H1013	centrifugation rack orange, for 50ml , 15ml	50	1pc*50bags

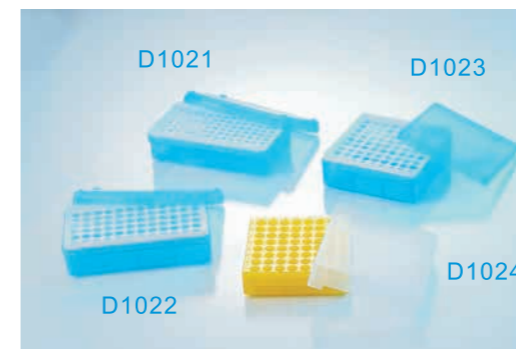

Pipette tips & Boxes

SYSTEM

The special Gongdong pipette tip is used to ensure the accuracy and precision of the experiment. The precision pipette tip provides optimum reproducibility and accuracy. Standard tip and tip with filter can be disinfected and sterilized in high pressure. The unique filter element silicified tip does not hang the residual liquid, which guarantees the accuracy of liquid transfer to the utmost. It almost meets and fits the requirements of most commercially available pipettes. It is also equipped with a variety of tip boxes.

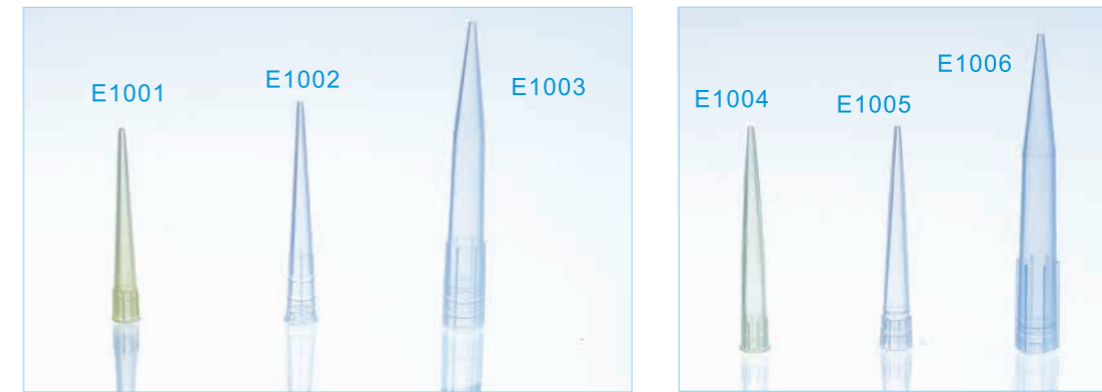

Item	Description of Goods	Quantity ^(pcs)	Packing
E1001	φ 4*31mm	50000	500pcs/bag*100bags
E1002	φ 6*50mm	50000	500pcs/bag*100bags
E1003	φ 8*71mm	10000	100pcs/bag*100bags
E1004	250ul φ 4*49mm	40000	500pcs/bag*80bags
E1005	250ul φ 6*50mm	50000	500pcs/bag*100bags
E1006	1000ul φ 8*71mm	10000	100pcs/bag*100bags
E1007	1000ul Fit For Eppendorf	10000	100pcs/bag*100bags
E1008	300ul Fit For Eppendorf	30000	1000pcs/bag*30bags
E1009	0.1-10ul φ 4*49mm Fit For Eppendorf	60000	1000pcs/bag*60bags
E1010	0.10-10ul φ 5*32mm Fit For Gilson	60000	1000pcs/bag*60bags
E1011	200ul φ 6*50mm (Yellow) Fit For Gilson	50000	500pcs/bag*100bags
E1012	200ul φ 6*50mm (Graduation) Fit For Gilson	30000	1000pcs/bag*30bags
E1013	1000ul φ 8*71mm Fit For Gilson	10000	100pcs/bag*100bags

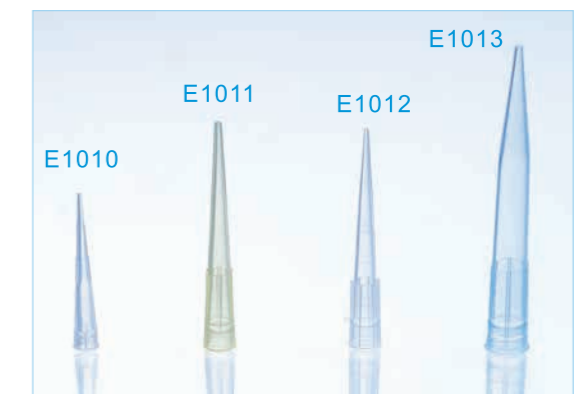

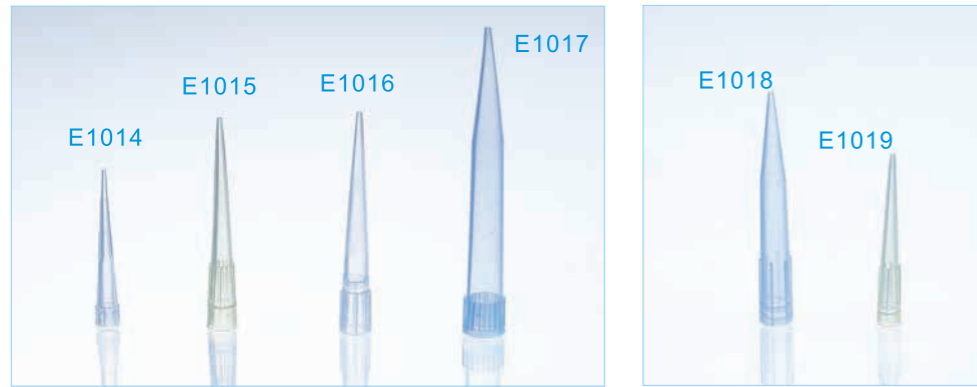

Item	Description of Goods	Quantity _(pcs)	Packing
E1014	0.10–10ul φ 5*32mm Fit For Finland	60000	1000pcs/bag*60bags
E1015	40–200ul 0.50–10ul φ 6*50mm Fit For Finland	30000	1000pcs/bag*30bags
E1016	250ul φ 6*52mm Fit For Finland	25000	1000pcs/bag*25bags
E1017	200–1000ul φ 8*71mm Fit For Finland	10000	100pcs/bag*100bags
E1018	200–1000ul φ 8*71mm Fit For Switzerland	10000	100pcs/bag*100bags
E1019	50–200ul φ 6*50mm Fit For Switzerland	50000	500pcs/bag*100bags
E1010-1	10ul With Filter	60000	1000pcs/bag*60bags
E1021-1	200ul With Filter	30000	1000pcs/bag*30bags
E1020-1	1000ul With Filter	10000	500pcs/bag*20bags
E1027	Fit for Uranus AE120	9600	500pcs/box*100boxs

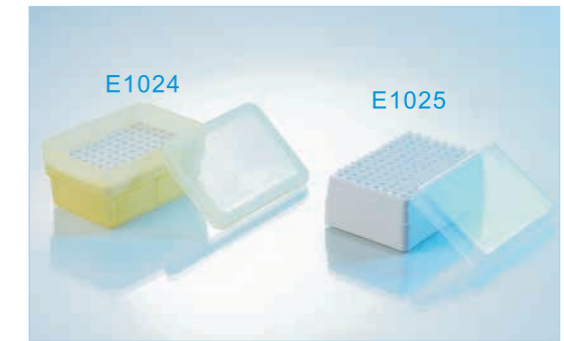
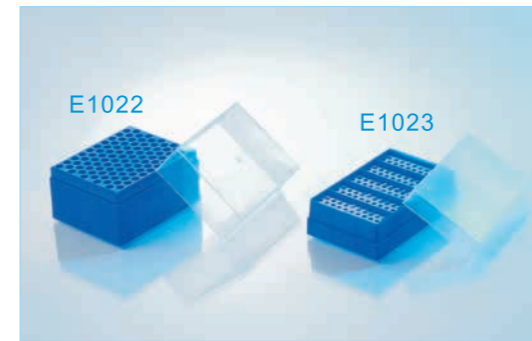
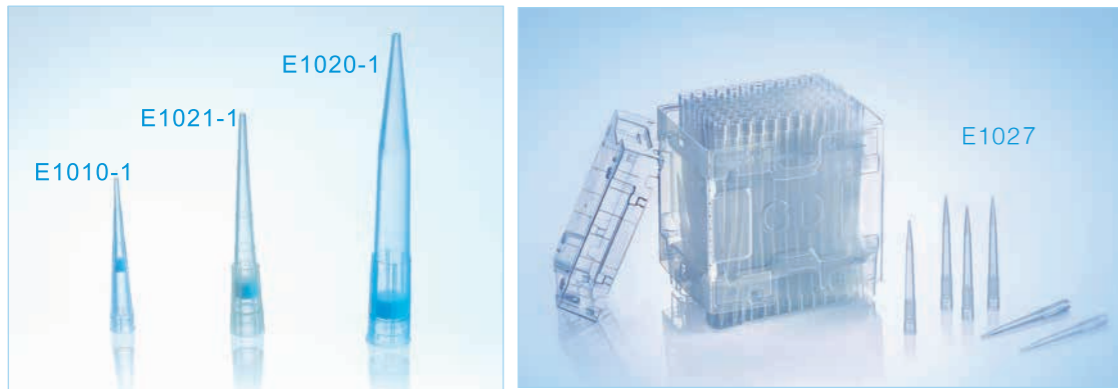

Item	Description of Goods	Quantity _(pcs)	Packing
E1022	Tips Box 100wells For 1000ul	30	bulk
E1023	Tips Box 200wells For 200ul	40	bulk
E1024	Tips Box 96wells For 200ul	68	bulk
E1025	Tips Box 96wells For 200ul&10ul	68	bulk
E1025-1			
E1032	Fit For ADDCON	10000	100pcs/bag*100bags
E1033	Fit For Siemens	8640	24box/carton
E1034	Fit For TECAN Freedom EVO 200 MAC 96 Workstation	24000	(1000pcs*2bags) /box*12boxs
E1035			
E3100	1000ul Fit For TECAN	4608	192pcs/box*24boxs
E3101	200ul Fit For TECAN	4608	192pcs/box*24boxs
E4503	50–300ul Fit For Finland	11520	384pcs/box*30boxs



Culture plate & pipettes

SYSTEM

The Gongdong culture plate adopts the most advanced surface treatment technology and manufacturing process of low-temperature polymer material at present in the world. A variety of series product such as cell culture flasks, cell culture plates, isotope flasks and coplin jars can be produced to meet the needs of single cell to large-scale cell and tissue cultures in a 100 thousand stage purification plant.

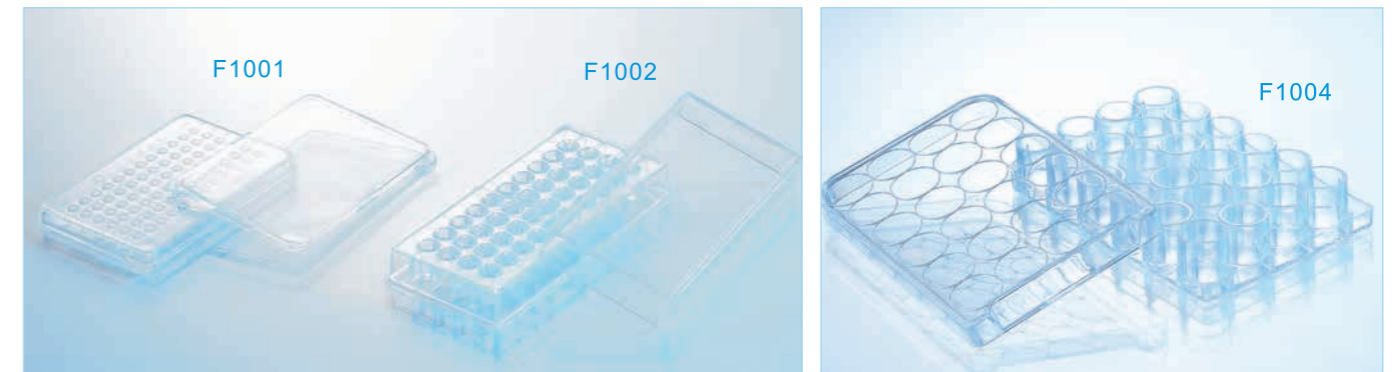

Item	Description of Goods	Quantity (pcs)	Packing
F1001	72 wells	800	1pc*800bags
F1002	40 wells	550/600	1pc*600bags with cap/1pc*550bags no cap
F1003-U	96wells plate(*U*bottom)	270	1pc*270bags
F1003-V	96wells plate(*V*bottom)	270	1pc*270bags
F1003-F	96wells plate(Flat bottom)	270	1pc*270bags
F1004	24wells	170	1pc*170bags

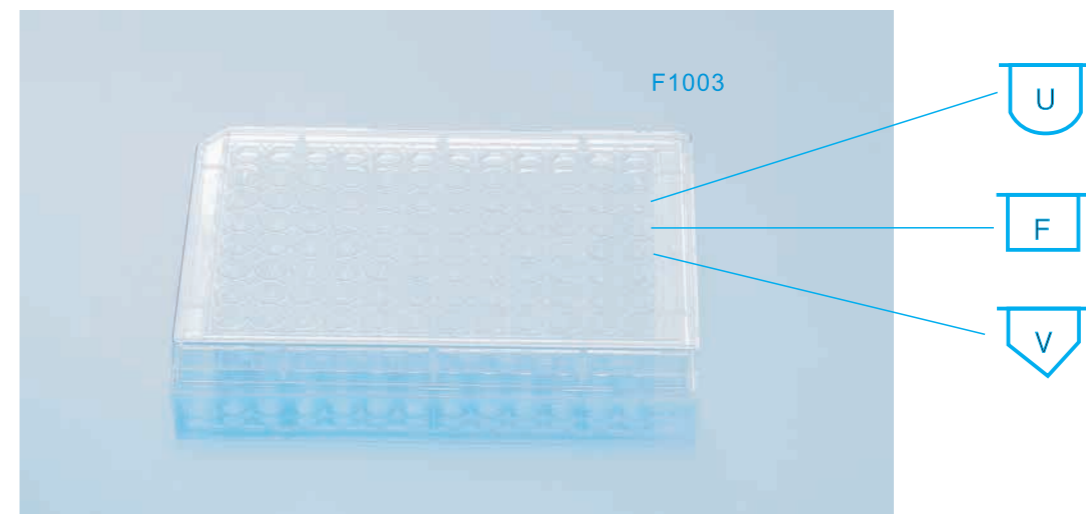

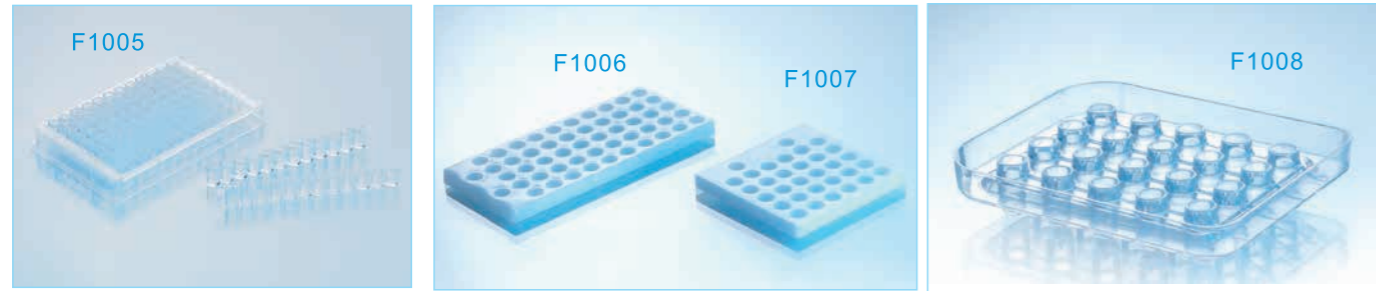

Item	Description of Goods	Quantity (pcs)	Packing
F1005	96wells detachable plat, suitable for 12 wells strip	270	1pc*270bags
F1006	52 Wells reaction plate	260	1pc*260bags
F1007	32 Wells rezction plate	360	1pc*360bags
F1008	20 Wells plate	180	1pc*180bags
F1021	96wells detachable plate, suitable for 8/12 wells strip	270	1pc*270bags
PET250	PET Cell Bottle 250ml	100	1pc*100bags
PET500	PET Cell Bottle 500ml	100	1pc*100bags
PET1000	PET Cell Bottle 1000ml	48	1pc*48bags

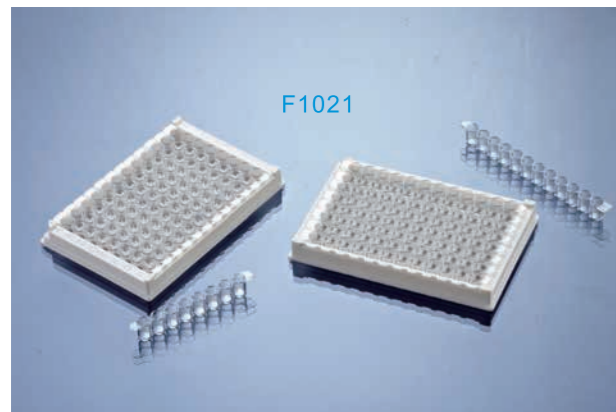

Embedding box is made of durable and porous molded plastic, which can secure the samples stored in liquid and completely avoid the chemical reaction of histological solvent and provide a variety of different colors for easily identifying different tissue samples.

Item	Description of Goods	Quantity (pcs)	Packing
F1009	Embedding Cassette	5000	500pcs*10bags
F1010	Embedding Cassette White	4000	500pcs*8bags
F1011	Embedding Cassette Green	2700	300pcs*9bags
F1030	Glass slides box	350	350pcs

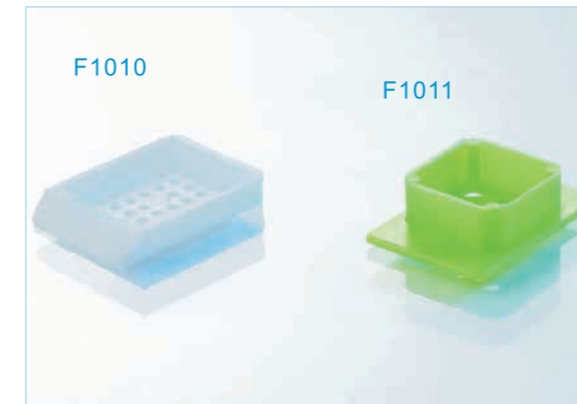

Plastic pipette fills the fragile defect of glass tube and ends the history of glass tubes and rubber plug for the transfer of high-risk contagiousness liquids. The interior of the pipette is smooth and reduces the damage to the tissue structure and cell in the liquid. It can transfer the liquid sample safely, rapidly and quantitatively.

It is resistant to low temperature and can be sterilized at high temperature.

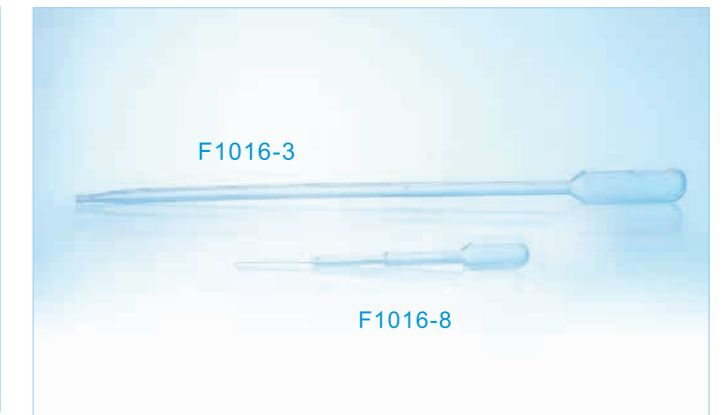
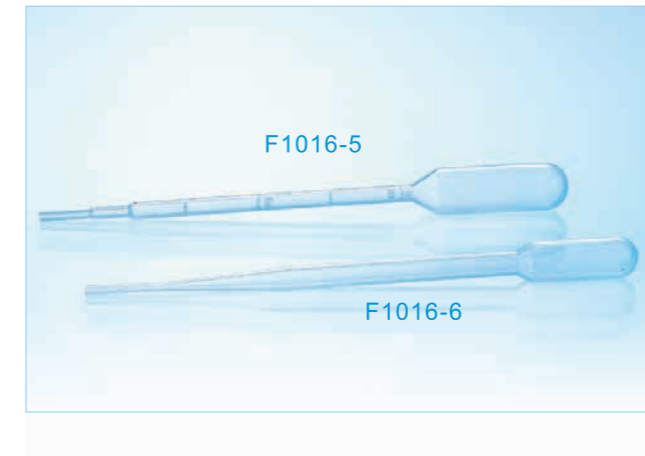
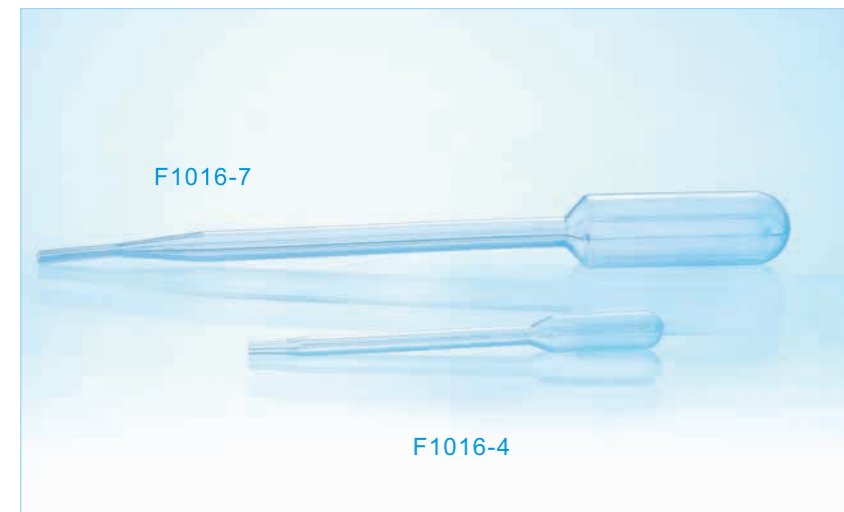
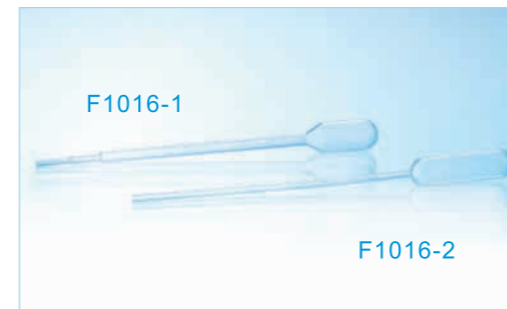
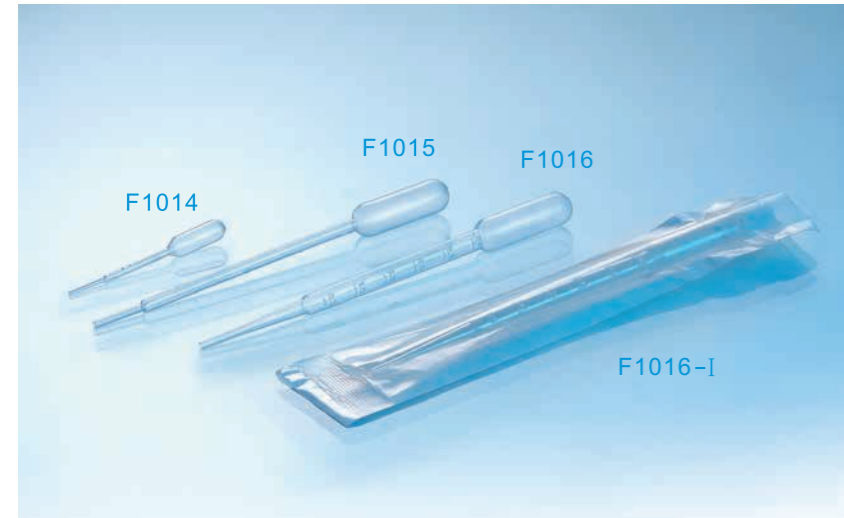

Item	Description of Goods	Quantity _(pcs)	Packing
F1014	25 ul & 35ul Transfer pipette	16000	2000pcs*8bags
F1015	1ml Transfer pipette	5000	250pcs*20bags
F1016	3ml Transfer pipette	5000	250pcs*20bags
F1016-i	3ml Transfer pipette paper plastic bag individual packing steaile	2500	1pcs*100bags*25bags
F1016-1	1.5ml Transfer pipette	5000	250pcs*20bags
F1016-2	1ml Transfer pipette	5000	250pcs*20bags
F1016-3	3.5ml Transfer pipette	4000	100pcs*40bags
F1016-4	1ml Transfer pipette	5000	250pcs*20bags
F1016-5	3.5ml Transfer pipette	4000	250pcs*16bags
F1016-6	2ml Transfer pipette	4000	100pcs*40bags
F1016-7	5ml Transfer pipette	4000	250pcs*16bags
F1016-8	1ml Transfer pipette	5000	250pcs*20bags
F1016-9	2ml Transfer pipette	5000	250pcs*20bags
F1016-11	Spherical pipette	4000	200pcs*20bags

Test tubes & Racks

SYSTEM

The Gongdong test tube series is made of material PP、PS. It is transparent, smooth and high chemically tolerant. Among them, the test tube made of material PP is resistant to weak acid, weak base, organic solvent and high temperature, which can offer various specifications, flat bottom, round bottom, and various lengths.

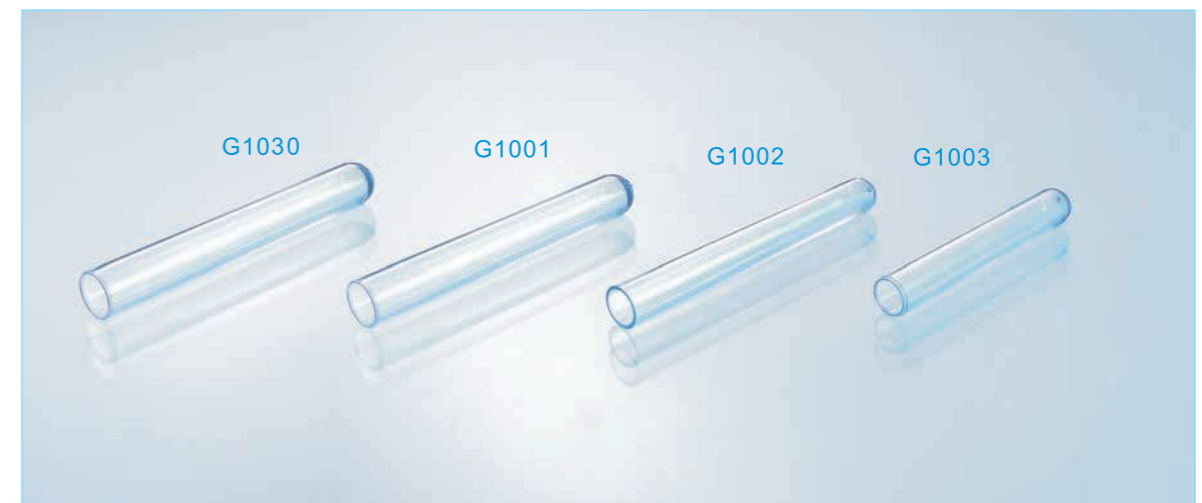

Item	Description of Goods	Quantity _(pcs)	Packing
G1030	16*100mm	1600	200pcs*8bags
G1001	15*100mm, 10ml	2000	200pcs*10bags
G1002	13*100mm, 7ml	3000	300pcs*10bags
G1003	13*78mm, 5.5ml	4008	334pcs*12bags
G1004	12*60mm, 3.5ml	6000	400pcs*15bags
G1005	12*75mm, 5ml	4800	400pcs*12bags
G1006	12*78mm, 5.5ml	4800	400pcs*12bags
G1007	16*53mm, 6mlwith cap	3000	300pcs*10bags



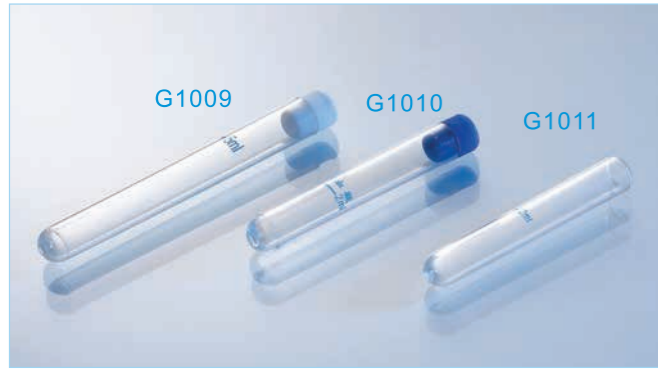

Item	Description of Goods	Quantity _(pcs)	Packing
G1009	13*100mm, 7ml with cap, with 5ml graduation	3000	300pcs*10bags
G1010	12*75mm, 5ml with cap, with 2ml graduation	4800	400pcs*12bags
G1011	12*60mm, 3.5ml, with 2ml graduation	6000	400pcs*15bags
G1012	12*75mm, 5ml, use for BD flow cytometry	4008	334pcs*12bags
G1013	12*75mm, 5ml, hexagonal bottom	4800	400pcs*12bags
G1032	12ml Test tube with rubber	4800	400pcs*12bags
G1031	16*95mm test tube with pipette	1500	150pcs*10bags

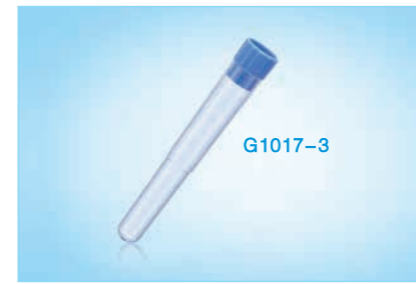
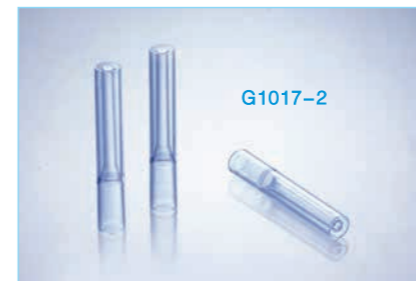
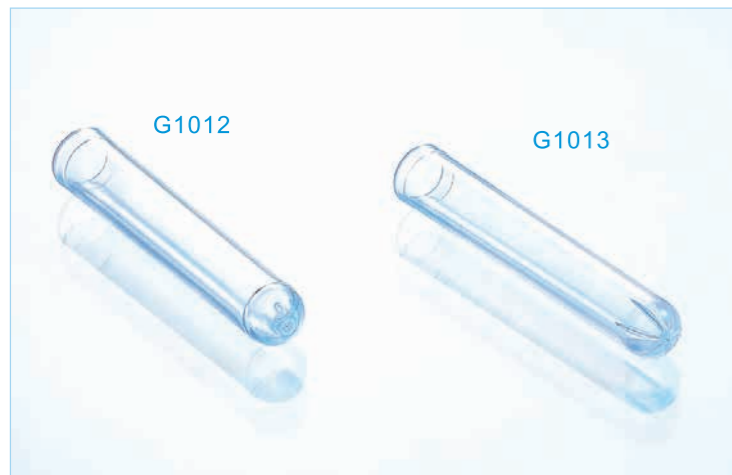

- G1017** Equipped with the card cover. The scale is accurate to 1/4, 1/2, 2ml. The total capacity is 12ml. It can withstand 3400 RPM of centrifugal. The test tube mouth is provided with a aqueduct for easy drip irrigation of specimens. This tube is suitable for pneumatic transmission system.

Item	Description of Goods	Quantity _(pcs)	Packing
G1017	12ml urine cup	1500	150pcs*10bags
G1017-1	12ml urine cup with cap	1500	150pcs*10bags
G1017-2	US urine test tue	1200	200pcs*6bags
G1017-3	urine test tube(new type) with cap	2000	100pcs*20bags

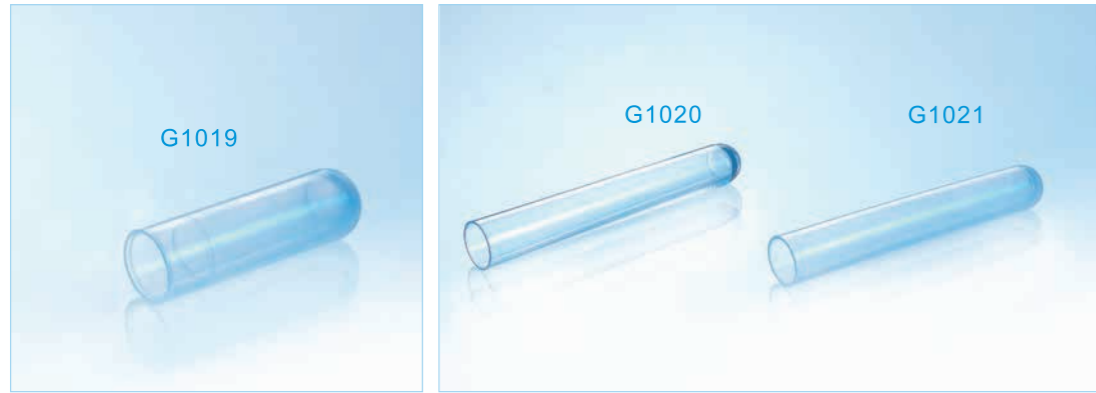

Item	Description of Goods	Quantity (pcs)	Packing
G1019	15*50mm, 4.5ml	3600	400pcs*9bags
G1020	13*78mm, 5.5ml	4800	400pcs*12bags
G1021	12*75mm, 5ml PP	4800	400pcs*12bags
G1027	15*150mm 15ml	1500	100pcs*15bags
G1028	Test tube with graduation, 14.7X101mm with cup. Color: transparent or amber	1000	100pcs*10bags

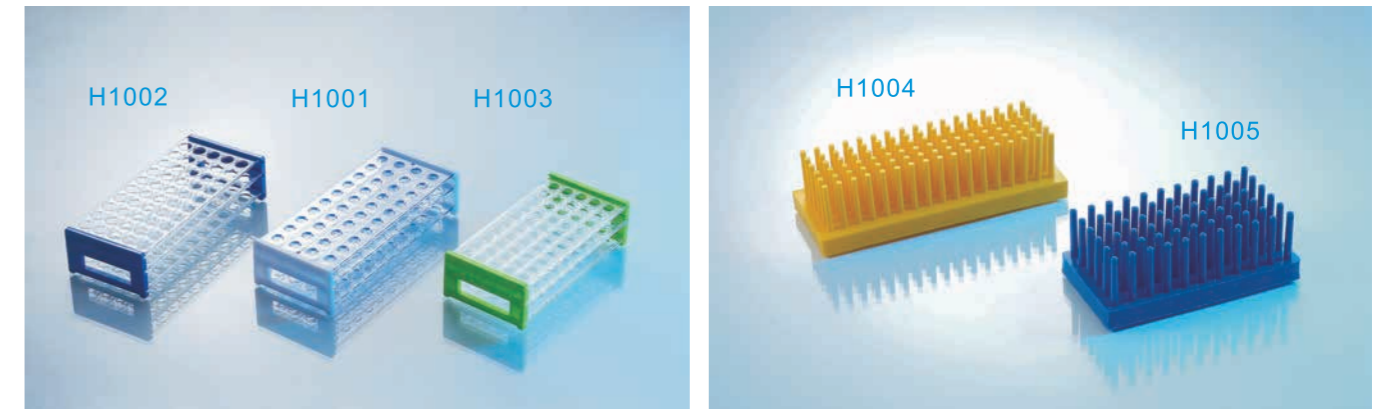
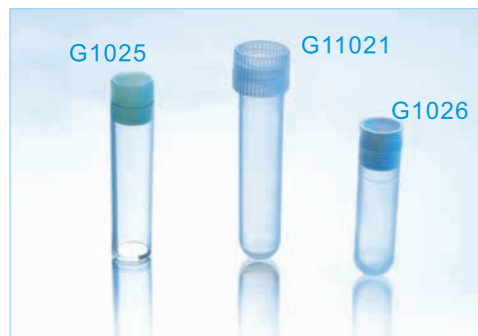

Item	Description of Goods	Quantity (pcs)	Packing
H1001	40Wells ϕ 18mm Tube Rack	40	2pcs/bag*20bags
H1002	50Wells ϕ 15mm Tube Rack	40	2pcs/bag*20bags
H1003	50Wells ϕ 13mm Tube Rack	40	2pcs/bag*20bags
H1004	Pillar-like ϕ 5*16Tube Rack	56	1pc*56bags
H1005	Pillar-like ϕ 5*10Tube Rack	56	1pc*56bags



● **H1018** 独特的底层装有硅胶垫片，采用特殊塑料做成，使试管架坚固耐用，不易破碎，能装大小各类试管。

Item	Description of Goods	Quantity (pcs)	Packing
H1018	Multi-Function Rack	50	1pc*50bags
H1019	Doble-Deek Multi-function Rack	25	1pc*25bags

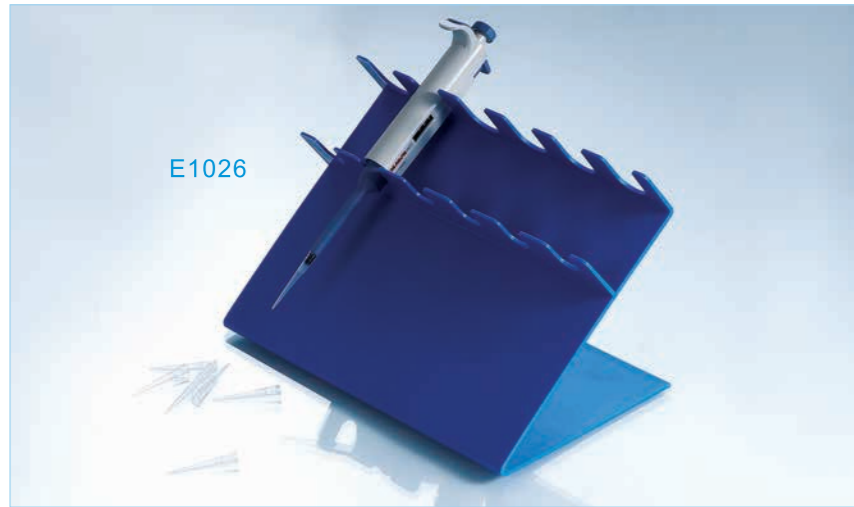

Item	Description of Goods	Quantity (pcs)	Packing
H1008	Washing plate Natural White	200	1pc*200bags
H1009	96 wells sample box for blood storage	210	in bulk
F1019	Reservoir type "V"	350	Individual Packing
E1026	Pipette shelf	10	in bulk



Cuvettes

SYSTEM

The Gongdong colorimetric cup series adopts imported optical plastics, and is casted with high precision mould. The inside and outside surface of the product is transparent, level and smooth with superior light transmission performance. It is suitable for all kinds of automatic biochemical analyzer, blood coagulation instrument and spectrophotometer at home and abroad.

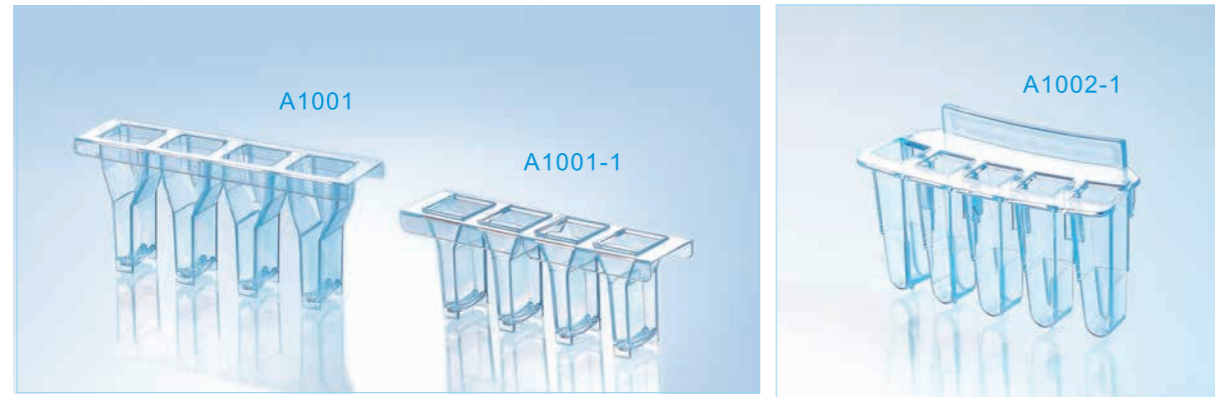

Item	Description of Goods	Quantity (pcs)	Packing
A1001	Tianjin Pulisheng & French stago	1600	50pcs/box*32boxes/ctn
A1001-1	Steellex	2300	72pcs/bag*32bags-4pcs
A1002-1	American MD 3000 Biochemical Analysis	960	240pcs/box*4boxes/ctn
A1003	CA100 mid-Asia	15000	1000pcs/bag*15bags/ctn
A1004	French Organon	2688	84pcs/bag*32bags/ctn
A1005	BN100 Special Protein Apparatus	2688	70pcs/box*32boxes/ctn



Item	Description of Goods	Quantity (pcs)	Packing
A1006	Roche Biochemical Analysis Cup	500	1pc*500bags
A1007	American Pacific, German TECO	3200	100pcs/bag*32bags/ctn
A1007-1	MC Coatron 1800	3200	100pcs/bag*32bags/ctn
A1008	Beckman	1500	100pcs/box*15boxes/ctn
A1008-1	Beckman TOP	1500	100pcs/box*15boxes/ctn

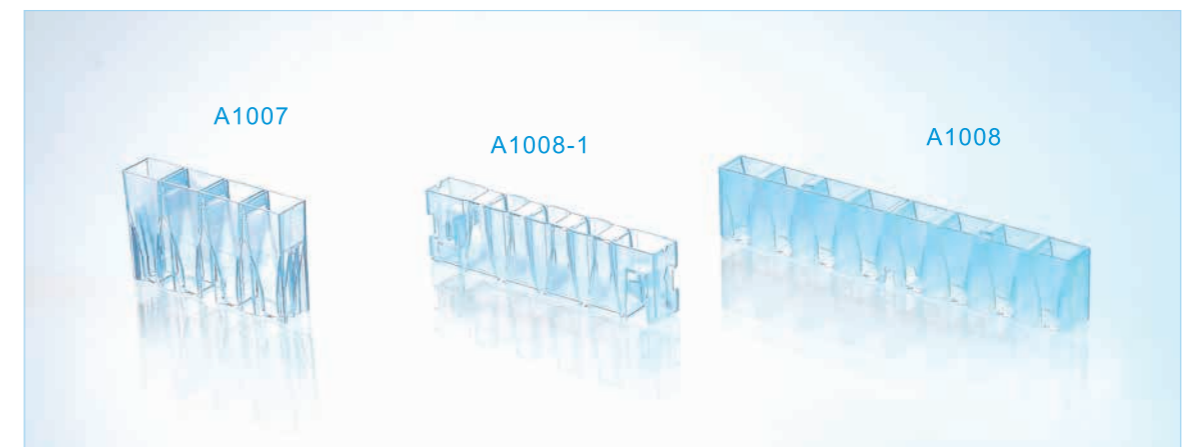

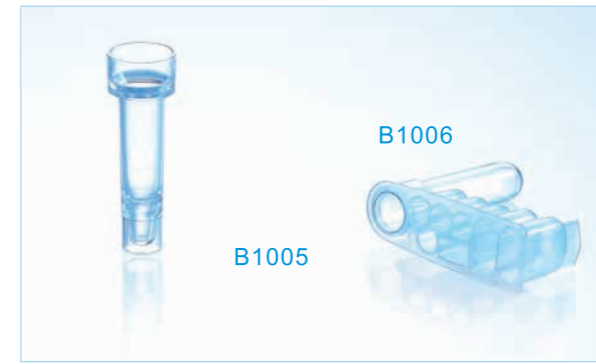
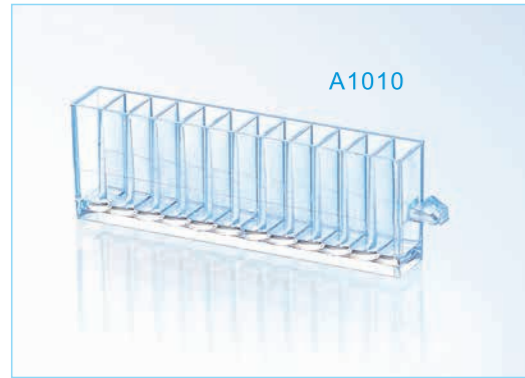

Item	Description of Goods	Quantity (pcs)	Packing
A1010	Finland Kangyi 12 Holes	3200	20pcs*5boxes/bag*32bags
A1011	American Corning cups 5 Holes	2366	13pcs/box*13boxes/bag*14boxes/ctn
A1012	Germany BECL4 8Holes	1000	25pcs/box*10boxes/bag*4boxes/ctn
A1015	German BE 4 Holes	3500	500pcs*7bags
A1017	German BE 1 Hole	24000	2000pcs*12bags
A1018	Spain Cruor Apparatus	8000	1000pcs*8bags
A1019	German LABOR	10000	1000pcs*10bags
A1020	German TECO Sample Cup	12000	1000pcs*12bags

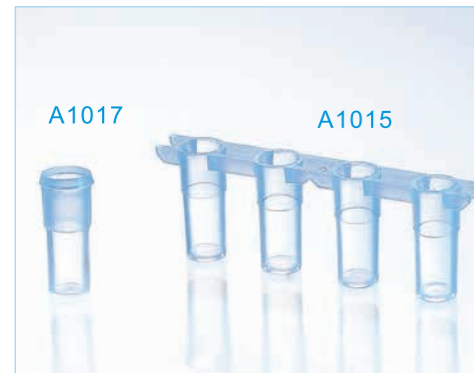

Item	Description of Goods	Quantity (pcs)	Packing
B1001	German BE Automatic	2610	261pcs*10bags
B1002	German SIGMA KC-40	12000	1000pcs*12bags
B1005	Yapei AXSYM	3600	400pcs*9bags
B1006	Yapei AXSYM reaction jar	1200	200pcs*6bags
B1007	Blood tube	3000	300pcs*10bags
B1009	Japan Dongya CA1500	20000	2000pcs*10bags
B1010	Japan Dongya CA530	20000	2000pcs*10bags
B1011	Japan Dongya Ca6000	20000	2000pcs*10bags
B1020	CA7000	20000	1000pcs*20boxes





Item	Description of Goods	Quantity (pcs)	Packing
B1025	Yapei R2000	10000	1000pcs*10boxes
B1026	Siemens ADVIA Centaur CP	6000	1000pcs*6bags
B1027	Siphon quantitative dropping pipette	10000	1000pcs*10bags
B1015	Rayto RAC-1800 hematology machine	20000	1000pcs*20boxes



Item	Description of Goods	Quantity (pcs)	Packing
B1012	American Beckman SpecialProtein ARRY-360 Sample Cup	400	40pcs*10bags
B1013	Color Dilution Plate	100	1*100box
B1014	Baolingman 10holes	1000	200pcs*5boxes
B1016	For Special Protein Analyzer	960	40pcs/box*24boxes
B1018	Laibang	20000	2000pcs*10bags





Item	Description of Goods	Quantity (pcs)	Packing
C1001	Hitachi 7150,7060 Series;Aulinbas 2ml	5000	500pcs*10bags
C1002	American Beckman CX Series,0.5ml	8000	1000pcs*8bags
C1003	IL Sample Cup,Monarch Biochemical Analysis Apparatus(0.5ml)	13000	1000pcs*13bags
C1004	American Beckman 700(1.5ml), American Dubang, Holland VITALAB SAMPLE CUP	8000	1000pcs*8bags
C1025	FC serum sample cup (L)	10000	1000pcs*10bags
C1026	FC serum sample cup (S)	10000	1000pcs*10bags
C1028	Beckman DXI800RV	12000	1000pcs*12bags
C1029	Analysis tube	2400	200pcs*12bags

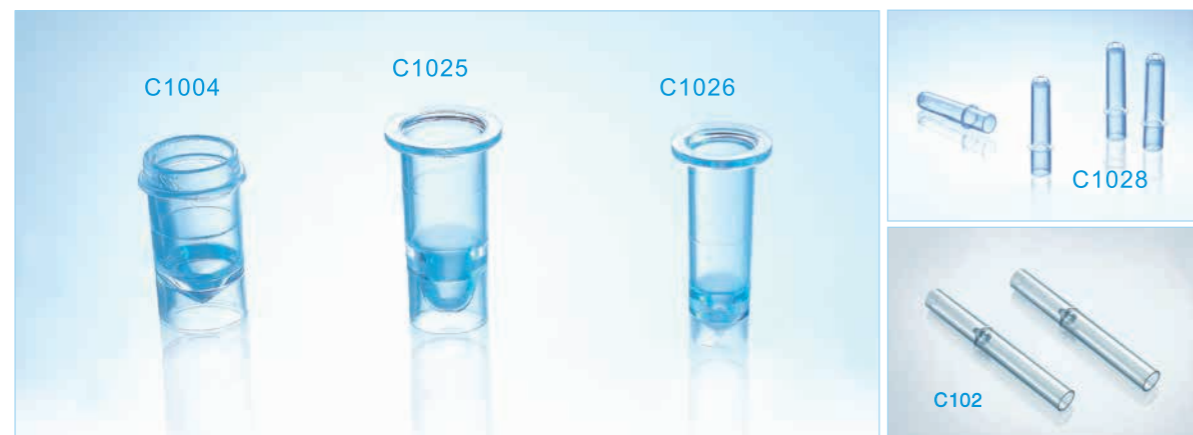

Item	Description of Goods	Quantity (pcs)	Packing
C1006	AC900(22*45)	2100	100pcs*21bags
C1010	Mairui(30*50)	10000	65pcs*153.8bags
C1016	F800 100holes sample rack	11	1pc*11bags
C1017	Hitachi Minimum	6000	500pcs*12bags
C1019	Hitachi Conical	9000	1000pcs*9bags
C1023	An'Tai 30 Holes Reaction Plate	900	1pc*900bags
C1024	Antai sample cup	2600	2000pcs*13bags



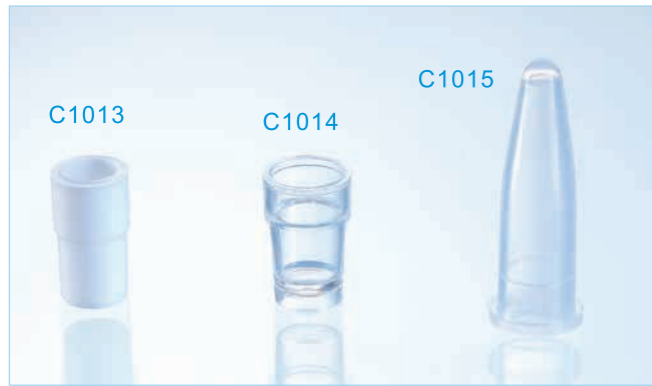

Item	Description of Goods	Quantity(pcs)	Packing
C1011	Holl ACE	24000	2000pcs*12bags
C1013	American M10,Italy BT2245 Biochemical Apparatus	20000	2000pcs*10bags
C1014	American Kangning 560, 550 Series	18000	2000pcs*9bags
C1015	American M10,Italy BT2245 Biochemical Apparatus	10000	1000pcs*10bags
C1020	Kodak Sample Cup	12000	1000pcs*12bags
C1021	Baolingman Sample Tube	40000	5000pcs*8bags
C1022	Kodak tip	16000	1000pcs*40bags
C1021-1	Baolingman black pipette tips	20000	1000pcs*20boxes
C1021-2	Roche Tip&Cup	48bo	6boxes/bag*8bags
C1021-5	Roche Tip(with box)	120	120boxes
C1021-6	Roche Cup(with box)	240	240boxes



Pharmaceutical packaging material

Gongdong got state food and drug administration approved, which includes oral solid pharmaceutical HDPE bottles (State Drug Packing Material Administration Approve No.:20130717) and oral liquid medicinal polyester bottles (State Drug Packing Material Administration Approve No.:20130122), PP Topical ointment bottles with the sealing (State Drug Packing Material Administration Approve No.:20060014), Drug-Prefilled PP vaginal syringes (State Drug Packing Material Administration Approve No.:20140075), Oral drops LDPE bottles (State Drug Packing Material Administration Approve No.:20060101). Gongdong imported advanced instruments and packaging machines from Germany, which can be used to R&D various specifications of products for various pharmaceutical manufacturers, biological products companies and hospitals. Nowadays, Gongdong have already built long-term cooperation with many well-known pharmaceutical industry, and became a well-known manufacturing base of drug packing material.

